

# OWNER'S MANUAL

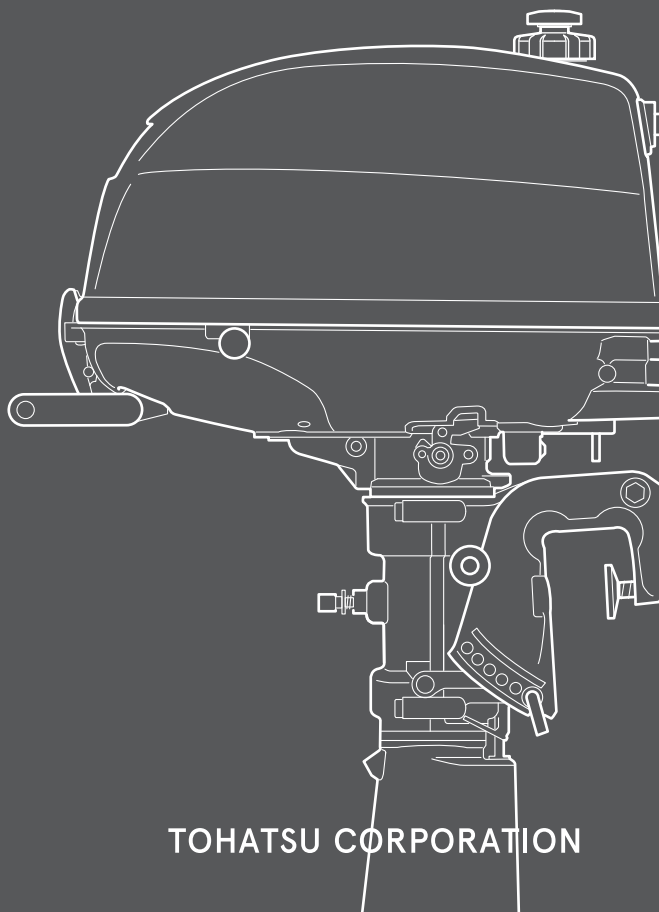

MFS 4D  
MFS 5D  
MFS 6D

OB No.003-11155-0BX1



**BACKS  
YOU  
UP™**

TOHATSU CORPORATION

 **WARNING:**

This product can expose you to chemicals including gasoline engine exhaust, which is known to the State of California to cause cancer, and carbon monoxide, which is known to the State of California to cause birth defects or other reproductive harm.

For more information go to [www.p65warnings.ca.gov](http://www.p65warnings.ca.gov).

---

ENOM00001-0

 **READ THIS MANUAL BEFORE USING THE OUTBOARD MOTOR. FAILURE TO FOLLOW THE INSTRUCTIONS AND SAFETY PRECAUTIONS IN THIS MANUAL CAN RESULT IN SERIOUS INJURY OR DEATH. KEEP THIS MANUAL IN A SAFE LOCATION FOR FUTURE REFERENCE.**

Copyright © 2020 Tohatsu Corporation. All rights reserved. No part of this manual may be reproduced or transmitted in any form or by any means without the express written permission of Tohatsu Corporation.

# YOUR TOHATSU OUTBOARD MOTOR

ENOM00006-A

## **To You, Our Customer**

Thank you for selecting a TOHATSU outboard motor. You are now the proud owner of an excellent outboard motor that will service you for many years to come.

This manual should be read in its entirety and the inspection and maintenance procedures described later in this manual should be followed carefully. Should a problem arise with the outboard motor, please follow the troubleshooting procedures listed at the end of this manual. If the problem persists, contact an authorized TOHATSU service shop or dealer.

All information in this manual is based on the latest product information available at the time of approval for printing.

Tohatsu Corporation reserves the right to make changes at any time without notice and without incurring any obligation.

Please always keep this manual together with the outboard motor as a reference to everyone who uses the outboard motor. If the outboard motor is resold, make sure the manual is passed on to the next owner.

We hope you will enjoy your outboard motor and wish you good luck in your boating adventures.

**TOHATSU CORPORATION**

ENOM00002-0

## **OWNER REGISTRATION AND IDENTIFICATION**

Upon purchasing this product, be sure that the WARRANTY CARD is correctly and completely filled out and mailed to the addressee noted there on. This WARRANTY CARD identifies you as the legal owner of the product and serves as your warranty registration.

TO THE EXTENT PERMITTED BY APPLICABLE LAW, YOUR OUTBOARD MOTOR WILL NOT BE COVERED BY THE APPLICABLE LIMITED WARRANTY, IF THIS PROCEDURE IS NOT FOLLOWED.

ENOM00003-0

## **PRE-DELIVERY CHECK**

Be sure that the product has been checked by an authorized TOHATSU dealer before you take delivery.

ENOM00005-A

**Serial Number**

In the space below, please record the outboard motor's serial number (indicated both on the bracket and on the cylinder block). The serial number will be needed when ordering parts, and when making technical or warranty inquiries.

**Serial Number:**

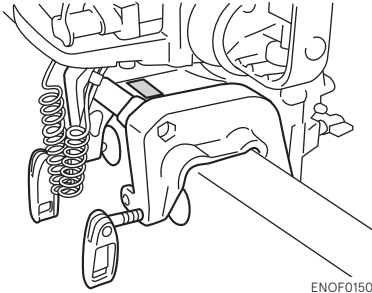

ENOF01500-1

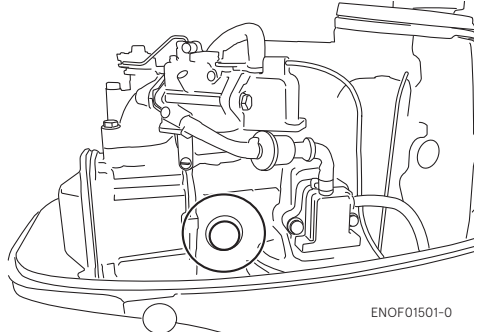

ENOF01501-0

Serial Number:

Date of purchase:

---

ENOM00007-0

**NOTICE: DANGER/WARNING/CAUTION/Note**

Before installing, operating or otherwise handling your outboard motor, be sure to thoroughly read and understand this Owner's Manual and carefully follow all of the instructions. Of particular importance is information preceded by the words "DANGER," "WARNING," "CAUTION," and "Note." Always pay special attention to such information to ensure safe operation of the outboard motor at all times.

ENOW00001-0

 **DANGER**

---

**Failure to observe will result in severe personal injury or death, and possibly property damage.**

---

ENOW00002-0

 **WARNING**

---

**Failure to observe could result in severe personal injury or death, or property damage.**

---

ENOW00003-0

 **CAUTION**

---

**Failure to observe could result in personal injury or property damage.**

---

ENON00001-0

**Note**

---

This instruction provides special information to facilitate the use or maintenance of the outboard motor or to clarify important points.

---



# CONTENTS

1. GENERAL SAFETY INFORMATION . . . . .	10
2. SPECIFICATIONS . . . . .	12
3. PARTS NAME . . . . .	14
4. LABEL LOCATIONS . . . . .	16
5. INSTALLATION . . . . .	20
1. Mounting the outboard motor on boat . . . . .	20
2. Altitude adjustment kit requirement . . . . .	21
3. Remote control device installation (option) . . . . .	22
4. Battery installation (For SP model) . . . . .	22
6. PRE-OPERATING PREPARATIONS . . . . .	24
1. Fuel handling . . . . .	24
2. Fuel filling . . . . .	25
3. Engine oil filling . . . . .	27
4. Break-In . . . . .	29
5. Warning system . . . . .	30
7. ENGINE OPERATION . . . . .	32
Before starting . . . . .	32
1. Fuel feeding . . . . .	32
2. Starting the engine . . . . .	34
3. Warming up the engine . . . . .	37
4. Forward, reverse, and acceleration . . . . .	38
5. Stopping the engine . . . . .	39
6. Steering . . . . .	40
7. Trim angle . . . . .	41
8. Tilt up and down . . . . .	42
9. Shallow water operation . . . . .	43
8. REMOVING AND CARRYING THE OUTBOARD MOTOR . . . . .	45
1. Removing the outboard motor . . . . .	45
2. Carrying the outboard motor . . . . .	45
3. Trailering . . . . .	46
9. ADJUSTMENT . . . . .	48
1. Steering friction . . . . .	48
2. Throttle grip friction . . . . .	48
10. INSPECTION AND MAINTENANCE . . . . .	49
1. Daily Inspection . . . . .	50
2. Periodic Inspection . . . . .	55
3. Off-season storage . . . . .	64
4. Pre-season check . . . . .	67
5. Submerged outboard motor . . . . .	67
6. Cold weather precautions . . . . .	68
7. Striking underwater object . . . . .	68
8. Auxiliary outboard motor operation . . . . .	68
11. TROUBLESHOOTING . . . . .	69

12. TOOL KIT AND SPARE PARTS .....	71
13. PROPELLER TABLE .....	72
14. EMISSION CONTROL SYSTEM INFORMATION .....	73



# INDEX

<b>1. GENERAL SAFETY INFORMATION</b>	<b>1</b>
.....	
<b>2. SPECIFICATIONS</b>	<b>2</b>
.....	
<b>3. PARTS NAME</b>	<b>3</b>
.....	
<b>4. LABEL LOCATIONS</b>	<b>4</b>
.....	
<b>5. INSTALLATION</b>	<b>5</b>
.....	
<b>6. PRE-OPERATING PREPARATIONS</b>	<b>6</b>
.....	
<b>7. ENGINE OPERATION</b>	<b>7</b>
.....	
<b>8. REMOVING AND CARRYING THE OUTBOARD MOTOR</b>	<b>8</b>
.....	
<b>9. ADJUSTMENT</b>	<b>9</b>
.....	
<b>10. INSPECTION AND MAINTENANCE</b>	<b>10</b>
.....	
<b>11. TROUBLESHOOTING</b>	<b>11</b>
.....	
<b>12. TOOL KIT AND SPARE PARTS</b>	<b>12</b>
.....	
<b>13. PROPELLER TABLE</b>	<b>13</b>
.....	
<b>14. EMISSION CONTROL SYSTEM INFORMATION</b>	<b>14</b>

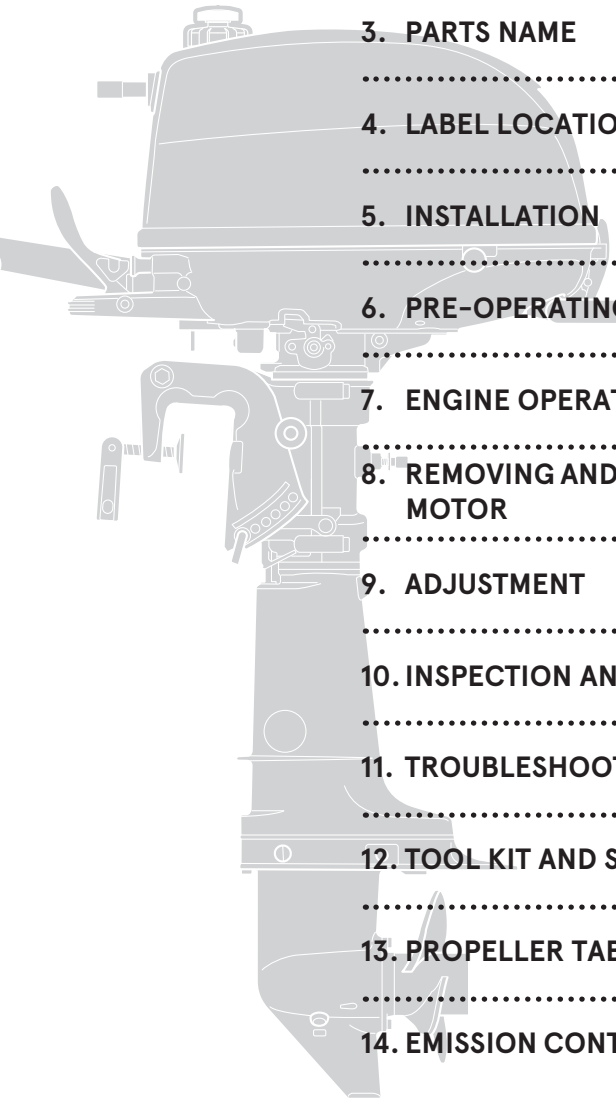

# GENERAL SAFETY INFORMATION

## 1

ENOM00009-0

### SAFE OPERATION OF BOAT

As the operator/driver of the boat, you are responsible for the safety of those aboard and those in other boat around yours, and for following local boating regulations. You should be thoroughly knowledgeable on how to correctly operate the boat, outboard motor, and accessories. To learn about the correct operation and maintenance of the outboard motor, please read through this manual carefully.

It is very difficult for a person standing or floating in the water to take evasive action should he or she see a power boat heading in his/her direction, even at a slow speed. Therefore, when your boat is in the immediate vicinity of people in the water, the outboard motor should be shifted to neutral and shut off.

ENOW00005-0

### WARNING

**SERIOUS INJURY IS LIKELY IF A PERSON IN THE WATER MAKES CONTACT WITH A MOVING BOAT, GEAR HOUSING, PROPELLER, OR ANY SOLID DEVICE RIGIDLY ATTACHED TO A BOAT OR GEAR HOUSING.**

ENOM00247-0

### STOP SWITCH LANYARD

The engine can be stopped with pulling out the stop switch lock from the stop switch. The stop switch lanyard is the coiled red cord with the stop switch lock on one end and a metal clip on the other end. With attaching the stop switch lanyard to the operator's body part or operator's personal flotation device (PFD), the engine will stop when the stop switch lanyard is being stretched and pulled out the lock from the switch when the operator falls accidentally overboard or leaves from operator's position. This function can be prevent losing control of and minimize or prevent risk of collision with boats, people and other objects. It is operator's responsibility to use the stop switch lanyard.

ENOW00004-1

### WARNING

**Accidental activation of the Stop Switch (such as the tether being pulled out in heavy seas) could cause passengers to lose their balance and even fall overboard, or it could result in loss of power in heavy seas, strong currents, or high winds. Loss of control while mooring is another potential hazard.**

**To minimize accidental activation of the Stop Switch, the 500 mm (20 inch.) stop switch lanyard is coiled and can extended to a full 1300 mm (51 inch.).**

ENOM00800-A

### PERSONAL FLOTATION DEVICE

As the operator/driver and passenger of the boat, you are responsible to wear a PFD (Personal Flotation Device) while on the boat.

ENOM00010-0

## **SERVICING, REPLACEMENT PARTS & LUBRICANTS**

We recommend that only an authorized service shop perform service or maintenance on this outboard motor. Be sure to use genuine parts, genuine lubricants, or recommended lubricants.

ENOM00011-A

## **MAINTENANCE**

As the owner of this outboard motor, you should be acquainted with correct maintenance procedures following maintenance section of this manual (See page 49). It is the operator's responsibility to perform all safety checks and to ensure that all lubrication and maintenance instructions are complied with for safe operation. Please comply with all instructions concerning lubrication and maintenance. You should take the engine to an authorized dealer or service shop for periodic inspection at the prescribed intervals. Correct periodic maintenance and proper care of this outboard motor will reduce the chance of problems and limit overall operating expenses.

### **Carbon Monoxide Poisoning Hazard**

Exhaust gas contains carbon monoxide, a colorless and odorless gas which can be fatal if inhaled for any length of time.

Never start or operate the engine indoors or in any space which is not well ventilated.

### **Gasoline**

Gasoline and its vapors are very flammable and can be explosive. Use extreme care when handling gasoline. You should be thoroughly knowledgeable on how to correctly handle gasoline by reading this manual.

# SPECIFICATIONS

ENOM00810-A

## MODEL FEATURE

2

Model		F4D	F5D	F6D		F6D SP*2
Type		(D) MF	MF	(D) MF	MF	MF
Transom heights	S	●	●	●	●	
	L	●	●	●	●	●
	UL					●
Tiller Handle		●	●	●	●	●
Remote Control *1		(●)	(●)	(●)	(●)	(●)
Separate fuel tank			●		●	●
Dual fuel tank		●		●		
Manual tilt		●	●	●	●	●

\*1: Option

\*2: SP model equip with charging coil as a standard.

ENOM00811-A

## MODEL NAME EXAMPLE

F 6 DSUL SP

F	6	D	S	UL	SP
Model description	Horse power	Product generation	Fuel tank	Shaft length	-
F= Four stroke	-	A and up	D=Integral & Separate (Option) S=Separate	S= Short 15 in L= Long 20 in UL= Ultra long 25 in	SP= SP model SP model equip with charging coil

EENOM00401-0

**MF**

2

Item	MODEL	4D(D) 6D(D) (Dual Tank)	5D(S) 6C(S) (Separate Tank)	6D(S) SP (Separate Tank)
Overall Length	mm (in)	783 (30.8)		
Overall Width	mm (in)	343 (13.5)		
Overall Height S-L-UL	mm (in)	Except for USA and Canada model 1051 (41.4) 1178 (46.4) 1350 (51.4)	1030 (40.6)	
		For USA and Canada model 1062 (41.8) 1189 (46.8) 1136 (51.8)	1157 (45.6) 1284 (50.6)	
Transom Height S-L-UL	mm (in)	436 (17.2)	563 (22.2)	690 (27.2)
Weight *3	S kg (lb)	26.1 (57)		25.6 (56)
	L kg (lb)	26.6 (59)		26.1 (57)
	UL kg (lb)	27.1 (60)		26.6 (59)
Output	kW (ps)	4D : 2.9 (4) 5D : 3.7 (5) 6D : 4.4 (6)		
Max. Operating Range	min <sup>-1</sup> (rpm)	4D & 5D : 4500-5500		6D : 5000-6000
Idle Speed in Forward Gear	min <sup>-1</sup> (rpm)	1150		
Idle Speed in Neutral Gear	min <sup>-1</sup> (rpm)	1300		
Engine Type		4-Stroke		
Number of Cylinder		1		
Bore × Stroke	mm (in)	59 × 45 (2.32 × 1.77)		
Piston Displacement	mL (Cu in)	123 (7.5)		
Exhaust System		Through hub exhaust		
Cooling System		Water cooling		
Engine Lubrication		Trochoid pump		
Starting System		Manual starter		
Ignition System		Flywheel Magneto C.D. ignition		
Spark Plug		NGK DCPR6E		
Alternator		12V 60W 5A (Max.) *1		
Trim Position		6		
Engine Oil	mL (fl.oz.)	API SF, SG, SH or SJ, SAE 10W-30/40, Approx. 450 (15.2)		
Gear Oil	mL (fl.oz.)	Genuine Gear Oil or API GL5, SAE #80-90, Approx. 195 (6.6S)		
Fuel		Unleaded Regular Gasoline : R+M/2: 87 or higher RON: 91 or higher		
Fuel Tank Capacity	L (US gal)	1.2 (0.30) Integral *2		12 (3.17) Separate
Gear Reduction Ratio		2.15 (13 : 28)		
Emission Control System		EM (Engine modification)		
Operator Sound Pressure (ICOMIA 39/94) dB (A)		79.0		
Hand Vibration Level (ICOMIA 38/94) m/sec2		7.2		

\*1: Equipped only for SP model, the other models OPTION.

\*2: In case of dual fuel tank system. Able to use together with 12 L separate tank.

Remark: Specifications subject to change without notice.

\*3 With propeller, with battery cable.

Tohatsu outboard is power rated in accordance with ISO8665 (propeller shaft output).

# PARTS NAME

ENOM00402-A

## 4D, 5D, 6D

3

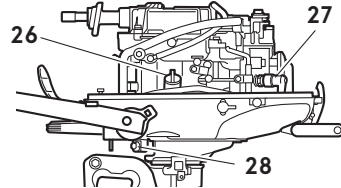
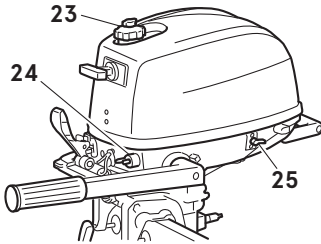
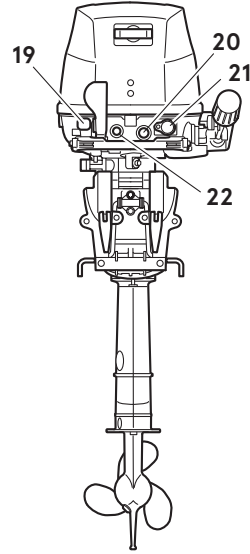
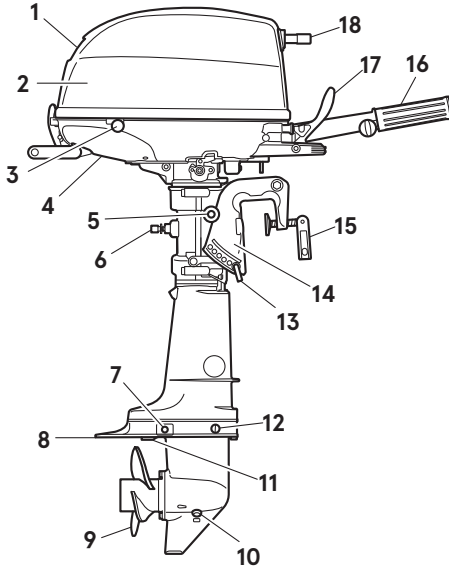

ENOF01502-1

- |                             |                   |                           |
|-----------------------------|-------------------|---------------------------|
| 1 Tilt Handle               | 13 Thrust Rod     | 25 Fuel Cock              |
| 2 Top Cowl                  | 14 Clamp Bracket  | 26 Engine Oil Filler Cap  |
| 3 Bottom Cowl               | 15 Clamp Screw    | 27 Spark Plug             |
| 4 Cooling Water Check Port  | 16 Throttle Grip  | 28 Engine Oil Drain Screw |
| 5 Tilt Lever                | 17 Shift Lever    |                           |
| 6 Steering Adjustment Screw | 18 Starter Handle |                           |
| 7 Anode                     | 19 Choke Knob     |                           |
| 8 Anti Ventilation Plate    | 20 Stop Switch    |                           |
| 9 Propeller                 | 21 Fuel Connector |                           |
| 10 Oil Plug (Lower) (Fill)  | 22 Warning Lamp   |                           |
| 11 Water Inlet              | 23 Air Vent Screw |                           |
| 12 Oil Plug (Upper) (Level) | 24 Fuel Connector |                           |

ENOM00822-0

## Remote control box & Fuel tank

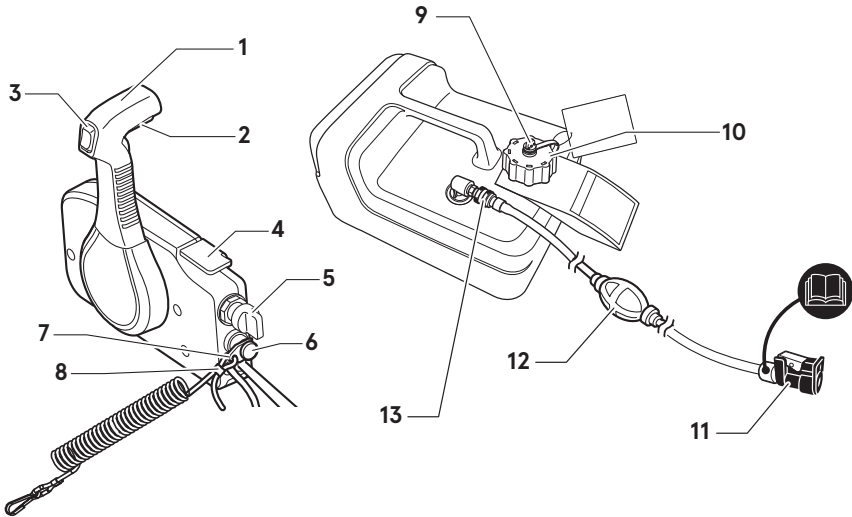

- |   |                     |    |                                 |
|---|---------------------|----|---------------------------------|
| 1 | Control Lever       | 9  | Air vent screw                  |
| 2 | Neutral lock arm    | 10 | Fuel tank cap                   |
| 3 | PTT switch          | 11 | Fuel connector (Engine side)    |
| 4 | Free throttle lever | 12 | Primer bulb                     |
| 5 | Main switch         | 13 | Fuel connector (Fuel tank side) |
| 6 | Stop switch         |    |                                 |
| 7 | Stop switch lock    |    |                                 |
| 8 | Stop switch lanyard |    |                                 |

ENOF01404-A2

# LABEL LOCATIONS

ENOM00019-A

## Warning label locations

4

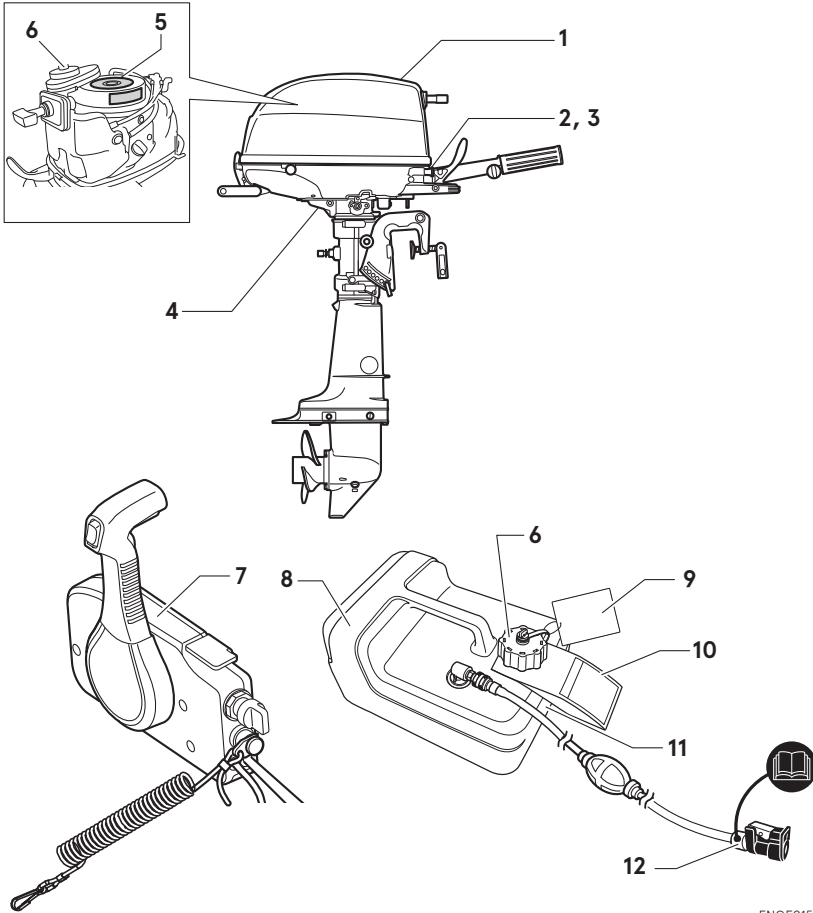



1. Warning regarding urge to read the owner's manual.



3WE-72180-000

2. Warning regarding oil pressure (See page 30).



ENOF00131-0

3. Warning regarding stop switch (See page 39)



ENOF00131-B

4. Warning regarding high temperature.



3GR-76191-0

- 5-1. Warning regarding high temperature.  
5-2. Warning regarding rotating object.  
5-3. Warning regarding high voltage



ENOF00005-S1

6. Warning regarding fuel tank cap (See page 25).

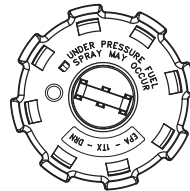

ENOF00012-0

7. Warning regarding engine stop switch.



ENOF00008-0

8. Warning regarding gasoline (See page 25).



REMOVE FROM BOAT  
FOR FILLING

ENOF00005-S

9. Warning tag regarding instructions of the fuel tank cap (See page 25).

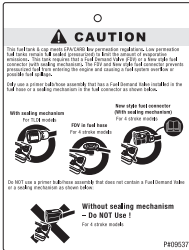

ENOF00010-0

10. Warning tag regarding instructions of the fuel tank cap (See page 25).



ENOF00011-0

11. Warning regarding gasoline (See page 25).



ENOF00005-L

12. Warning mark regarding of fuel connector (See page 25).



ENOF00005-J

ENOM00019-A

## ECI (Emission Control Information) label locations

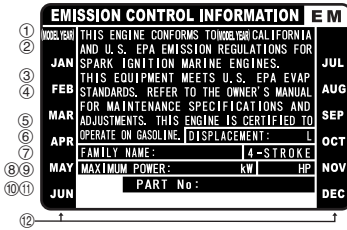

- ① EMISSION CONTROL INFORMATION
- ② THIS ENGINE CONFORMS TO (MODEL YEAR) CALIFORNIA AND U.S. EPA EMISSION REGULATION FOR SPARK IGNITION MARINE ENGINES.
- ③ THIS EQUIPMENT MEETS U.S. EPA EVAP STANDARDS.
- ④ REFER TO THE OWNER'S MANUAL FOR MAINTENANCE SPECIFICATIONS AND ADJUSTMENTS.
- ⑤ THIS ENGINE IS CERTIFIED TO OPERATE ON GASOLINE.
- ⑥ DISPLACEMENT
- ⑦ FAMILY NAME
- ⑧ MAXIMUM POWER
- ⑨ OUTPUT
- ⑩ TRADEMARK & NAME OF MANUFACTURER
- ⑪ PART No.
- ⑫ MODEL YEAR AND MONTH

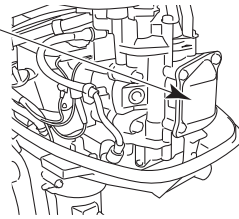

ENOF01504-B

### EPA Emissions Regulations

Outboards sold by Tohatsu America Corporation in the United States are certified to the United States Environmental Protection Agency as conforming to the requirements of the regulations for the control of air pollution from new outboard engines. This certification is contingent on certain adjustments being set to factory standards. For this reason, the factory procedure for servicing the product must be strictly followed and, wherever practicable, returned to the original intent of the design.

**Maintenance, replacement, or repair of the emission control devices and systems may be performed by any marine engine repair establishment or individual.**

The Emission Control Information label was affixed to engines as permanent evidence of EPA certification.

### Emissions Warranty Coverage WARRANTY INFORMATION

#### Four Stroke Outboard Limited Warranty

Canadian and California residents who have purchased an outboard motor from a Canadian and California dealer receive additional warranty coverage for specific emissions related components. To fully understand your warranty coverage please read our standard warranty statement and the Emission Warranty Statement provided by your dealer.

# INSTALLATION

ENOM00024-B

## 1. Mounting the outboard motor on boat

ENOW00006-0

### WARNING

Most boats are rated and certified in terms of their maximum allowable horsepower, as shown on the boat's certification plate. Do not equip your boat with an outboard motor that exceeds this limit. If in doubt, contact your dealer.

Do not operate the outboard motor until it has been securely mounted on the boat in accordance with the instructions below.

5

ENOW00009-1

### WARNING

- Mounting the outboard motor without following this manual can lead to unsafe conditions such as poor maneuverability, lack of control or fire.
- Loose clamp screws can lead to the release or displacement of the outboard motor, possibly resulting in lost of control and/or serious personal injury. Be sure that clamp screws are tightened securely. Check the clamp screws for tightness from time to time.

Keep the outboard motor in a vertical position when mounting.

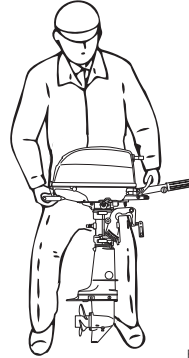

ENOF01505-1

ENOM00025-0

### Position ... Above keel line

Place the outboard motor in the center of the boat's transom.

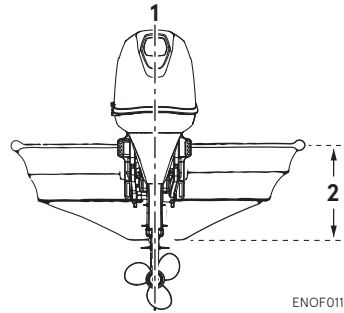

ENOF01141-0

1. Center of boat
2. Boat transom

ENOM00026-0

### Transom matching

Be sure that the anti ventilation plate of the outboard motor is 5–25 mm (0.2–1 in) below the bottom of hull.

If the above condition cannot be met due to the shape of the bottom of your boat, please consult your authorized dealer.

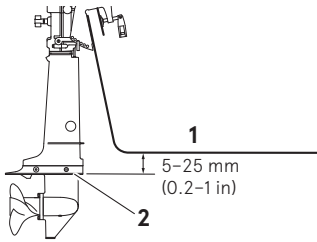

ENOF01506-0

- 1. Bottom of hull
- 2. Anti ventilation plate

ENOW00007-A

**CAUTION**

- Before beginning the running test, check that the boat with maximum capacity loading floats on the water in a proper attitude. Check the position of water surface on the driveshaft housing. If the water surface is near the bottom cowling, in high waves, water may enter the engine cylinders.
- Incorrect outboard motor mounting height or existence of underwater object(s), such as hull bottom design, bottom surface conditions or underwater accessories, can cause water spray possibly reaching the engine through an opening of the bottom cowling during cruising. Exposing the engine to such conditions for extended periods can lead to severe engine damage.
- Tighten the clamp screws sufficiently, otherwise falling down of outboard could be happened.

ENOM00831-0

**Mounting the outboard motor**

1. Set the outboard motor to appropriate position.
2. Tighten the clamp screws by turning their handles.
3. Secure the outboard motor to the boat with a rope to prevent accidental loss of the outboard motor overboard.

ENON00930-0

**Note**

Do not use tools to tighten clamp screws. Over tightening could result in damage to the clamp screws and clamp brackets.

ENON00002-0

**Note**

A rope is not included in the standard accessories.

5

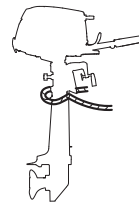

ENOF01507-A

ENOM00726-A

**2. Altitude adjustment kit requirement**

**High altitude:**

When engine operates at high altitude (over 1000m/3280ft) engine may need to have a high altitude kit installed. Otherwise, operating the engine at high altitude may increase its emissions and decrease fuel efficiency and performance. Contact authorized Tohatsu dealer for more detail.

ENOM00840-0

### 3. Remote control device installation (option)

ENOM00850-0

#### Remote control box location

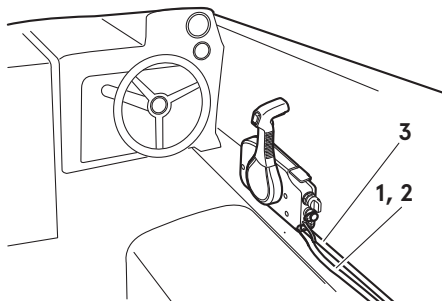

ENOF00841-1

1. Shift cable
2. Throttle cable
3. Cable harness B

Install the remote control box in a position where it is easy to reach and operate the controls.

Make sure there are no obstacles that can interfere with the operation of the remote control cable.

ENOM00860-0

#### Remote control cable length

ENOW00100-A

### CAUTION

Be careful not to loop the remote control cables to a diameter of 406 mm (16 inches) or less. Otherwise, it affects the service life of the cable.

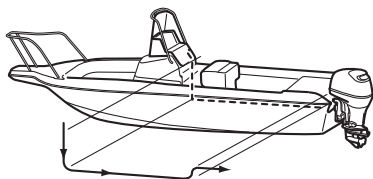

ENOF00842-0

Measure the distance from the remote control box to the outboard motor where the remote control cable should be routed.

Prepare a cable that is 300-450mm (11.8-17.7in) longer than the measured distance.

Temporarily pull the cable along the intended cable route to check its length is sufficient.

Connect the remote control cable to the engine, then run the cable to the remote control box, making sure it is not sharply bent, too taut and free from obstructions that could interfere with steering.

ENOM00029-A

### 4. Battery installation (For SP model)

ENOW00012-0

### WARNING

**Battery electrolyte contains sulfuric acid and thus is hazardous, causing a burn if it comes in contact with your skin, or poisonous if swallowed.**

**Keep battery and electrolyte away from reach of children**

**When handling the battery, be sure to:**

- Read all warnings shown on the battery case
- Prevent electrolyte from coming in contact with any part of your body. Contact can cause serious burn or, if it comes in contact with your eye, loss of sight. Use safety glasses and rubber gloves.

**In case battery electrolyte comes in contact with:**

- Skin, flush thoroughly with water.
- Eye, flush thoroughly with water, and then seek immediate medical treatment.

**In case battery electrolyte is swallowed:**

- Seek immediate medical treatment.

ENOW00013-B

**WARNING**

Battery generates explosive hydrogen gas. Be sure to:

- Charge the battery in a well-ventilated place.
- Place the battery away from any source of fire, sparks and open flames such as burners or welding equipment.
- Do not charge the battery when the electrolyte level is low. Otherwise, the battery will be damaged and may cause malfunction.

ENOW00014-0

**CAUTION**

- Make sure that the battery leads do not get stuck between the outboard motor and boat when turning, etc.
- The starter motor may fail to operate if the leads are incorrectly connected.
- Be sure to correctly connect the (+) and (-) leads. If not, the charging system will be damaged.
- Do not disconnect the battery leads from battery while the engine is operating, the electrical parts could be damaged.
- Always use a fully charged battery.

ENOW00015-0

**CAUTION**

Do not use a battery that is not recommended. Use of a battery not recommended can lead to poor performance of, and/or damage to, the electrical system.

ENON00006-C

**Note**

Minimum battery requirements: 12V 40Ah/20HR, 330 Cold Cranking Amps (CCA) Specifications and features of batteries vary among the manufacturers. Consult the manufacturer for details.

\* The battery should be purchased separately and is not supplied with the outboard motor.

1. Connect the battery cable to the leads that come from the bottom cowl.
2. Place the battery box in a convenient position away from possible water spray. Securely fasten both the box and the battery so they do not shake loose.
3. Connect the positive lead (+) to the positive terminal (+) of the battery, and then connect the negative lead (-). When disconnecting the battery always remove the negative lead (-) first. After connecting the positive terminal (+), securely place a cap on it to prevent short circuits.

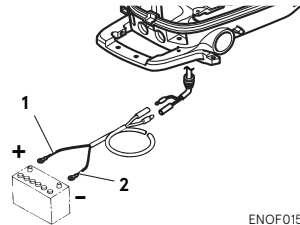

1. Battery cord (red)
2. Battery cord (black)

ENOF01508-0

# PRE-OPERATING PREPARATIONS

ENOM00030-A

## 1. Fuel handling

ENOW000017-0

### CAUTION

**Use of improper gasoline can damage your engine. Engine damage resulting from the use of improper gasoline is considered misuse of the engine, and damage caused thereby will not be covered under the limited warranty.**

ENOM00031-A

## FUEL RATING

TOHATSU engines will operate satisfactorily when using a major brand of unleaded gasoline meeting the following specifications:

**USA and Canada** — having a posted pump Octane Rating of 87 (R+M)/2 minimum. Premium gasoline (92 [R+M]/2 Octane) is also acceptable. Do not use leaded gasoline.

**Outside USA and Canada** — Use unleaded gasoline with declared octane rating of 91 RON or over. Use of premium gasoline of 98 RON is also allowed.

ENOM00032-A

## GASOLINES CONTAINING ALCOHOL

The fuel system components on your TOHATSU engine will withstand up to 10% ethyl alcohol (hereinafter referred to as the "ethanol"), content in the gasoline. But even if the gasoline in your area contains ethanol less than 10%, you should be aware of certain adverse effects that can occur. Increasing the percentage of ethanol in the fuel can also worsen these

adverse effects. Some of these adverse effects are caused because the ethanol in the gasoline can absorb moisture from the air, resulting in a separation of the water/ethanol from the gasoline in the fuel tank.

These may cause increased:

- Corrosion of metal parts
- Deterioration of rubber or plastic parts
- Fuel permeation through rubber fuel lines
- Starting and operating difficulties

If the use of gasoline containing alcohol is inevitable, or presence of alcohol is suspected in the gasoline, it is recommended to add a filter that has water separating capability, and check the fuel system for leaks and mechanical parts for corrosion and abnormal wear more frequently.

And, in case any of such abnormality is found, discontinue the use of such gasoline and contact our dealer immediately.

If the outboard motor will only be used infrequently, please see the remarks on fuel deterioration in the STORAGE chapter (P page 64) for additional information.

ENOW00020-1

### CAUTION

**When operating a TOHATSU engine on gasoline containing alcohol, storage of gasoline in the fuel tank for long periods should be avoided. Long periods of storage, create unique problems. In cars, alcohol blend fuels normally are consumed before they can absorb enough moisture to cause trouble, but boats often sit idle long enough for phase separation to take place. In addition, internal corrosion may take place during**



storage if alcohol has washed protective oil films from internal components.

ENOW00018-0

### WARNING

Fuel leakage can cause fire or explosion, potentially leading to severe injury or loss of life. Every fuel system part should be checked periodically, and especially after long term storage, for fuel leak, change of hardness of rubber, expansion and/or corrosion of metals. In case any indication of fuel leakage or degradation of fuel part is found, replace relevant part immediately before continuing operation.

ENOM00043-B

## 2. Fuel filling

ENOW00019-1

### WARNING

Do not fill the fuel tank over capacity. The rise of gasoline temperature may cause gasoline to expand which, may leak through air vent screw when it is open. Leaking gasoline is a dangerous fire hazard.

ENOW00028-A

### WARNING

Consult an authorized dealer for details on handling gasoline, if necessary.

Gasoline and its vapors are very flammable and can be explosive.

When carrying a fuel tank containing gasoline:

- Close the fuel tank cap and air vent screw of fuel tank cap, or gasoline vapor will be emitted through the air vent screw, creating a fire hazard.
- Do not smoke.

When or before refueling:

- Be sure to remove the static electricity charged in your body before refueling.
- The sparks due to static electricity may cause explosion of flammable gasoline.
- Stop the engine, and do not start the engine during refueling.
- Do not smoke.
- Be careful not to overfill fuel tank. Wipe up any spilled gasoline immediately.

When or before cleaning the gasoline tank:

- Dismount fuel tank from the boat.
- Place the fuel tank away from every source of ignition, such as sparks or open flames.
- Do the work outdoors or in a well ventilated area.
- Wipe off gasoline well immediately if spilled.

After cleaning gasoline tank:

- Wipe off gasoline well immediately if spilled.
- If the fuel tank is disassembled for cleaning, reassemble carefully. Imperfect assembly may cause a fuel leak, possibly leading to fire or explosion.
- Dispose aged or contaminated gasoline in accordance with local regulations.

ENOW00029-A

### WARNING

When opening fuel tank cap, be sure to follow the procedure described below. Fuel could blast out through the fuel tank cap in case the cap is loosened by using another procedure when internal pressure of fuel tank is raised by heat from sources such as sun light.

**1. When using integral tank**

Full open the air vent screw on the tank cap and release internal pressure.

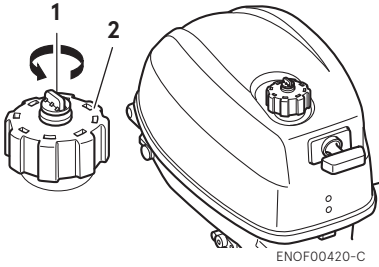

- 1. Air vent screw
- 2. Fuel tank cap

ENOF00420-C

**3. When using integral tank**

Remove top cowl and fill the fuel not to over the full mark.

**When using separate tank**

Fill the fuel carefully not to over flow.

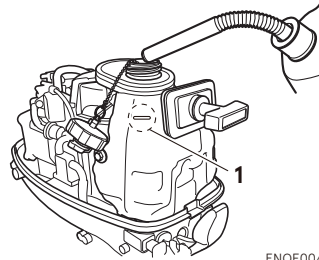

ENOF00418-0

- 1. Full mark

6

**When using separate tank**

- 1. Full open the air vent screw on the tank cap and release internal pressure.

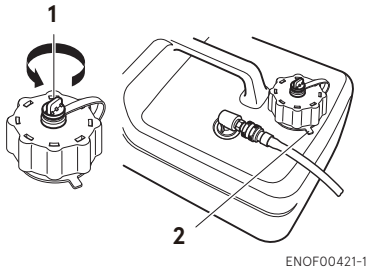

ENOF00421-1

- 1. Air vent screw
- 2. Fuel tank cap

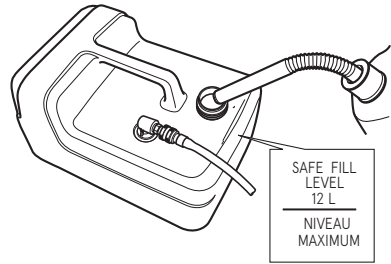

ENOF00419-A

- 4. After filling the tank, close the fuel tank cap until two clicks sound is heard.

**2. When using integral tank**

Open the fuel tank cap slowly.

**When using separate tank**

Loosen the tank cap until it contacts the tab lock and release internal pressure completely. After that, press down the tab lock and open the tank cap.

ENOM00037-C

### 3. Engine oil filling

ENOW00022-1

**CAUTION**

The engine oil is drained for shipping from the factory. Be sure to fill the engine to the proper level before starting engine.

ENOW00092-A

**CAUTION**

- Do not overfill engine oil, or engine oil could leak and/or engine could be damaged. If engine oil level is over upper limit marks of oil gauge, drain oil to level lower than upper limit.
- Be sure that outboard motor is in upright and level position when checking or changing oil.
- Stop engine immediately if low oil pressure warning lamp is lit or oil leak is found, or engine could be severely damaged. Consult dealer.
- Wipe off engine oil well immediately if spilled and dispose of it in accordance with local fire prevention and environment protection regulations.

1. Place the engine in a vertical position.
2. Remove the top cowl and the oil filler cap (dipstick).
3. Fill the engine through filler port with recommended oil to the middle of dipstick mark.
4. Tighten the oil filler cap (dipstick).

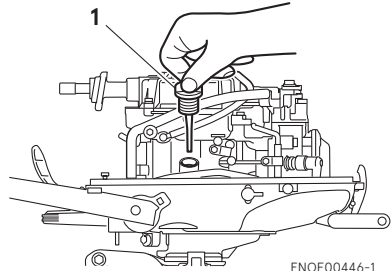

ENOF00446-1

1. Oil filler cap (Dipstick)



ENOF01531-0

1. Upper limit
2. Lower limit

#### Engine oil recommendation

Use only high quality 4-stroke outboard motor oil to insure performance and prolonged engine life.

SAE: 10W-30 or 10W-40

API: SF,SG,SH or SJ

Engine oil viscosity must be selected from the following chart according to the average temperatures in your area.

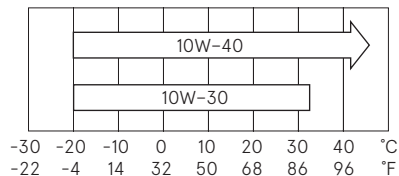

ENOF00208-0

**Engine oil volume**

Approximately 450 mL (0.48 US qt.)

ENOW0002A-A



**CAUTION**

**Use of engine oils that do not meet these requirements will result in reduced engine life, and other engine problems.**

---

ENOM00033-A

## 4. Break-In

Your new outboard motor and lower unit require break-in for the moving components according to the conditions described in the following time table.

Please refer to ENGINE OPERATION section (See page 32) to learn how to correctly start and operate the outboard motor.

ENOW00024-A

### DANGER

**Do not operate the outboard motor in closed area or area with no forced ventilation.**

**Exhaust gas emitted by this outboard motor contains carbon monoxide that will cause death if inhaled continuously. Inhaling the gas initially causes symptoms such as feeling of sickness, drowsiness and headache.**

**During operation of the outboard motor:**

- Keep peripheral area well ventilated.

- Always attempt to stay on the windward side of emission.

ENOW00023-1

### CAUTION

**Operating the outboard motor without break-in can shorten service life.**

**If any abnormality is experienced during the break-in:**

- Discontinue the operation immediately.
- Have the dealer check the product and take proper action(s) if necessary.

ENON00008-0

### Note

Proper break-in allows outboard motor to deliver it full performance for longer service life.

	1-10 min	10 min – 2 hrs	2-3 hrs	3-10 hrs	After 10 hrs
Throttle Position	Idle	Less than 1/2 throttle	Less than 3/4 throttle	3/4 throttle	Full throttle available
Speed		Approx. 3000 min <sup>-1</sup> (rpm) max	Full throttle run allowed for 1 min every 10 min	Approx. 4000 min <sup>-1</sup> (rpm). Full throttle run allowed for 2 min every 10 min	

ENOM00039-A

## 5. Warning system

If outboard motor encounters an abnormal condition of fault, warning lamp (LED) will be on (engine will not be stopped).

See next page for conditions which will lead to an abnormal condition or fault.

ENOM00040-D

### Location of warning lamp

#### ■ Warning lamp (LED)

Tiller handle models: Located on the bottom cowl.

6

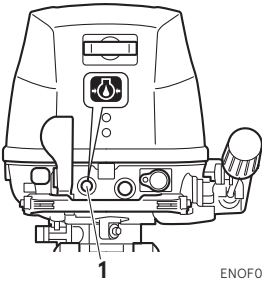

ENOF00415-1

1. Warning lamp

ENOM00041-D

## Warning indicators, faults and remedy

Warning indicators			Description of faults	Remedy
Sound	Lamp (LED)	ESG		
-	On for several sec.l		Normal system test when start up	
-	ON	ON	Engine speed exceeds maximum allowable RPM	<b>1</b>
-	ON	-	Low oil pressure*1	<b>2</b>

Remarks

\*1: In this case, oil pressure switch is "ON".

### High speed ESG (Electronic Safety Governor)

High speed ESG is a device to prevent over revolution of the engine. If the load to the engine becomes light for some reason, it runs at a higher speed than the usual. In such the case, the buzzer sounds and the ESG is activated not to ignite the spark plug, therefore, the engine speed varies and be controlled under 6300min<sup>-1</sup> (rpm).

### Remedy

1. Reduce the throttle to less than half opening, and move to safe place quickly, and stop the engine.  
Check the propeller for bent or damaged blades.  
Consult an authorized dealer if engine shows the same result even after replacing propeller with new one.
2. Move to safe place quickly, and stop the engine.  
Check the engine oil level, and add engine oil if necessary.  
Consult your dealer if the engine oil level is too low or too high.

ENOW00025-B

 **CAUTION**

**High speed ESG ON: Engine speed will be limited to 6300 min<sup>-1</sup> (rpm) and engine will run rough until throttle is reduced.**

# ENGINE OPERATION

ENOM00042-0

## Before starting

ENOM00246-0

### Oil Level checking

Check the engine oil level before each use. If the oil level is low or too high, the life of the engine will be shortened significantly. (To properly check the engine oil level follow the instructions, see page 51)

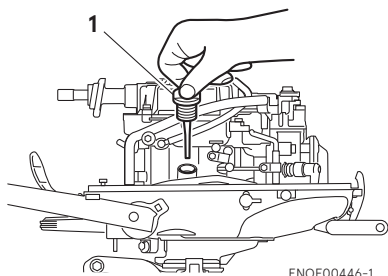

ENOF00446-1

1. Oil filler cap (Dipstick)



ENOF01531-0

1. Upper limit
2. Lower limit

ENOW00027-D

## CAUTION

Before starting engine for the first time after reassembling engine or off-season storage, disconnect stop switch lock and crank approximately 10 times in order to circulate oil through the engine.

ENOM00044-D

## 1. Fuel feeding

ENOW00029-A

### WARNING

When opening fuel tank cap, be sure to follow the procedure described below. Fuel could blast out through the fuel tank cap in case the cap is loosened by using another procedure when internal pressure of fuel tank is raised by heat from sources such as sun light.

ENOW00030-B

### WARNING

When using EPA approval fuel tank, only use a primer bulb/hose assembly that has a Fuel Demand Valve (FDV) installed in the fuel hose or a sealing mechanism in the fuel connector as shown below.

FDV and fuel connector that has an sealing mechanism prevent pressurized fuel spillage when the fuel connector is connected to the engine.



ENOF00035-0

1. FDV in fuel hose
2. Sealing mechanism in fuel connector
3. Identification



Do NOT use a primer bulb/hose assembly that does not contain a Fuel Demand Valve or a sealing mechanism as shown below: otherwise fuel spillage may occur when the connector is connected to the engine.



ENOF00036-0

Do not connect fuel connector except when operating engine. Fuel leakage is a fire or explosion hazard, which can cause serious injury or death.

ENOW00403-0

### ⚠ CAUTION

When separate tank is used for dual tank model, be sure to open air vent of integral tank as well as air vent of separate tank. If air vent of integral tank that contains fuel is closed, swelling of air in the tank by heat from engine can cause increase of internal pressure of the tank dangerously.

1. Full open the air vent screw on the tank cap.
2. **When using integral tank**  
Open the fuel tank cap slowly and release internal pressure completely. After that, close the fuel tank cap  
**When using separate tank**  
Loosen the tank cap until contacts the tab lock and release internal pressure completely. After that, close the fuel tank cap.
3. Set fuel cock lever to which you would like to use.

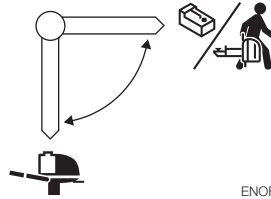

ENOF00422-1

ENOW00404-0

### ⚠ CAUTION

When using integral tank, disconnect fuel connector.

4. If you use a separate tank, connect the fuel connector to the engine side with pushing fuel connector lever. And then, connect the fuel connector to the fuel tank side.

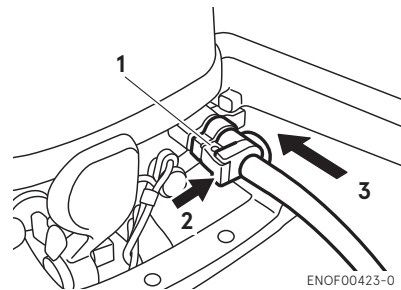

ENOF00423-0

1. Fuel connector
2. Push
3. Insert

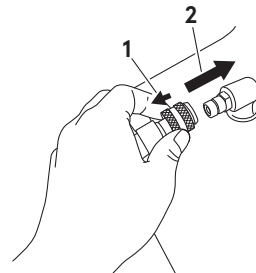

ENOF00861-A

1. Pull
2. Insert

- Squeeze primer bulb until it becomes stiff to feed fuel to carburetor. Direct arrow mark upward when priming.



ENOF00862-0

- Engine side
- Fuel tank side

Do not squeeze primer bulb while engine running or when the outboard motor is tilted up. Otherwise, fuel could overflow.

ENOM00045-C

7

## 2. Starting the engine

ENOW00958-0

### WARNING

- Do not remove or install the top cowl after the engine has been started.
- The exposed rotating engine parts or moving parts cause serious injury.

ENOW00959-0

### CAUTION

The top cowl must be installed while the engine running except in an emergency. If the top cowl is not installed correctly, water splash can damage the engine.

ENOW00036-A

### CAUTION

When the engine is started in the test tank, to avoid over heating and water pump damage, be sure the water level is at least 10 cm (4 in.) above the anti ventilation plate.

And be sure to remove the propeller, when starting the engine in the test tank. (See page 59)

Run the engine only at idling.

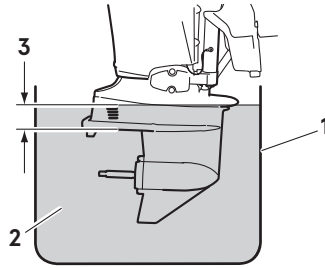

ENOF00863-0

- Test tank
- Water
- Over 10 cm (4 in.)

ENOW00036-0

### CAUTION

Be sure to stop engine immediately if cooling water check port is not discharging water, and check if cooling water intake is blocked. Operating engine could lead to overheating potentially leading to engine damage. Consult an authorized dealer if the cause cannot be found.

ENOW00032-B

### CAUTION

Do not try to crank after engine has started.

This model is provided with start in gear protection.

ENON00010-0

### Note

Start-in-gear protection prevents engine from starting at other than neutral shift. In-gear starting of engine will move the boat immediately, potentially leading to falling down or causing passenger(s) to be thrown overboard.

## Tiller handle type

1. Be sure to install the stop switch lock to the stop switch, and attach the stop switch lanyard securely to the operator or to the operator's PFD (Personal Flotation Device.)

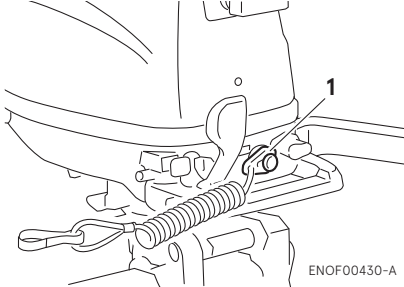

ENOF00430-A

1. Stop switch lock
2. Set the shift lever in the Neutral position.

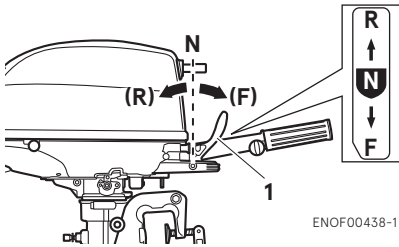

ENOF00438-1

1. Shift lever
3. Set the throttle grip to START position.

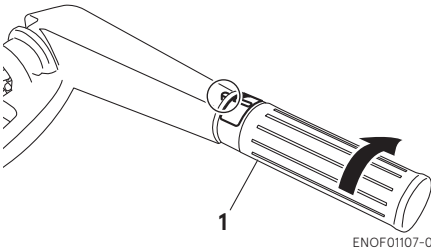

ENOF01107-0

1. Throttle grip

4. Pull the choke knob fully.

ENON00501-0

### Note

Choke is not necessary when the engine is warm. Set the throttle grip to "RE-START" position.

ENON00502-0

### Note

If engine does not start with 4 or 5 times starting operation, push the knob back and restart.

5. Pull the starter handle slowly until you feel engagement, keep pulling till you feel less resistance. Then pull it quickly. repeat if necessary until started.

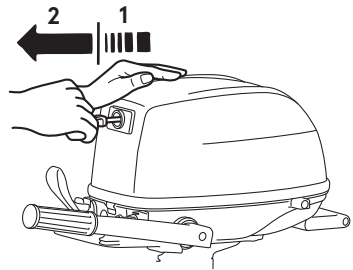

ENOF00432-1

1. Slowly
2. Quickly

ENOW00064-0

## ⚠ CAUTION

**Engine may be hot immediately after operating and could cause burns if touched. Allow engine to cool down before attempting to carry the outboard.**

6. After engine starting, return the choke knob while check the engine speeds. if the engine speeds unstable, pull the choke knob to operated.

7. Check the cooling water from cooling water check port.

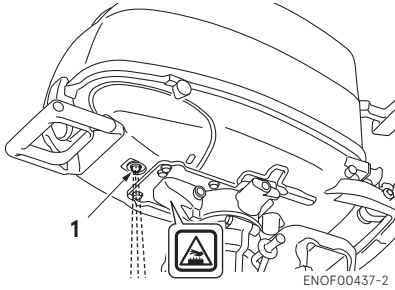

1. Cooling water check port

ENOM00042-A

### Emergency starting

ENOW00099-A

## WARNING

When the emergency starter rope is used for starting engine;

- Start in gear protection does not work. Be sure to shift is at neutral position. Otherwise the engine will move the boat immediately and cause personal injury.
- Be careful that your clothes or other items do not get caught in the rotating engine parts.
- To prevent accident and injury by rotating parts, do not re-attach flywheel cover and the top cowl after the engine has been started.
- Do not pull starter rope if any bystander is behind. The action can injure the bystander.
- Attach engine stop switch lanyard to clothing or any part of body like arm before starting engine.

1. Remove the top cowl.

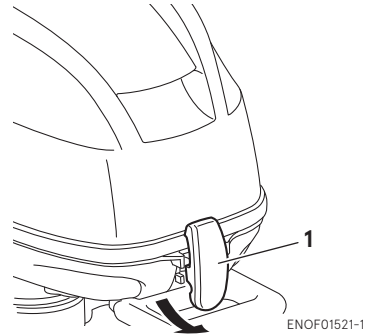

1. Cowl latch
2. Disconnect the rick of the starter lock rod.

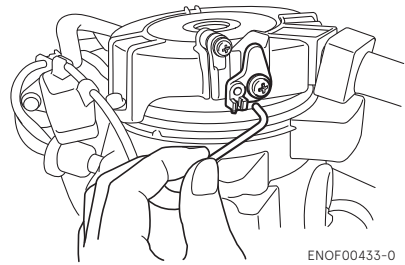

3. Remove the bolts (3 pcs) and remove the recoil starter.

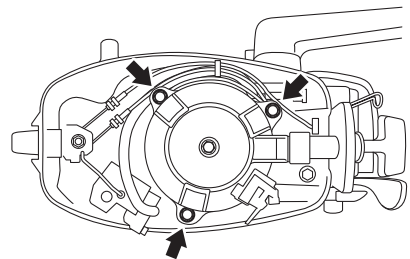

4. Insert the knotted end of the starter rope into the notch in the flywheel and wind the rope around the flywheel several turns clockwise.

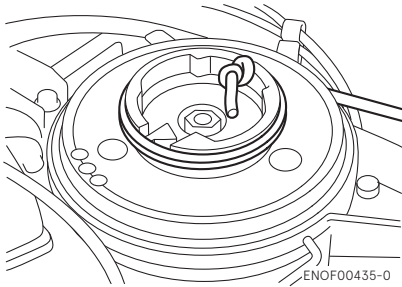

5. Tie a loop in the another end of the emergency starter rope and attach socket wrench that is included in the tool kit.

ENOW00860-0

**⚠ CAUTION**

**Be sure to keep the harness away from the rotation parts.**

6. Be sure to install the stop switch lock to the stop switch, and attach the stop switch lanyard securely to the operator or to the operator's PFD (Personal Flotation Device.)
7. Set the control lever in the Neutral position.
8. Pull the starter handle slowly until you feel engagement, keep pulling till you feel less resistance. Then pull it quickly.

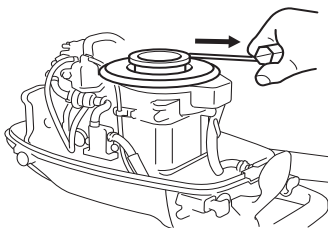

9. After engine starts, do not reinstall recoil starter and top cowl.

ENOM00043-A

### 3. Warming up the engine

ENOW00932-0

**⚠ CAUTION**

**Be sure to check that cooling water is coming out of the cooling water check port during warm up.**

Warm the engine at low engine speeds for about

- 3 minutes : above 5°C (41°F)
- 5 minutes at 2000 min<sup>-1</sup> (rpm) : below 5°C (41°F)

This allows the lubricating oil to circulate to all parts of the engine. Operating the engine without warm up shortens the engine's life.

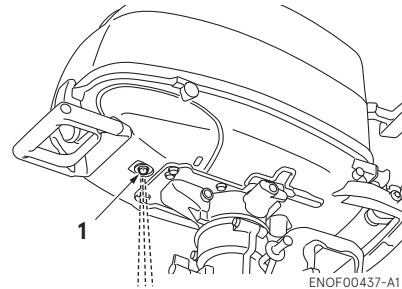

1. Cooling water check port

ENOM00044-0

### Engine speeds

Idling speed after warming up.

Remark: In case of cold engine starting, idling speed is increased about 400 min<sup>-1</sup> (rpm) for several minutes.

Clutch in (In gear)	Clutch off (Out of gear)
1100 min <sup>-1</sup> (rpm)	1300 min <sup>-1</sup> (rpm)

ENOM00046-A

#### 4. Forward, reverse, and acceleration

ENOW00037-0

#### WARNING

Before shifting into forward or reverse, make sure that boat is properly moored and out-board motor can be steered fully to the right and left. Make sure that no swimmer(s) is ahead or astern of the boat.

ENOW00038-A

#### WARNING

- Attach other end of emergency stop switch lanyard to the operator's PFD (Personal Flotation device) or arm and keep it attached during cruising.
- Do not attach the tether to a part of clothing that can be torn easily when pulled.
- Arrange the tether so that will not be caught by any object when pulled.
- Be careful not to pull the tether accidentally during cruising. Unintentional stop of engine can cause loss of control of out-board motor. Rapid loss of engine power can lead to falling down or causing passenger(s) to be thrown overboard.

ENOW00042-0

#### WARNING

- Do not shift into Reverse during planing, or control will be lost leading to serious personal injury, boat may swamp, and/or hull may be damaged.
- Do not shift into Reverse during cruising, or control may be lost, falling down or causing passenger(s) to be thrown overboard. Leading to serious personal injury, and steering system and/or shifting mechanism may be damaged.

ENOW00861-0

#### WARNING

Do not shift at high boat speed, or control may be lost, falling down or causing passenger(s) to be thrown overboard. Leading to serious personal injury.

ENOW00862-0

#### CAUTION

Gear and clutch damage may occur if shifting at high engine speed.  
Engine must be in the slow idle position before shifting is attempted.

ENOW00863-0

#### CAUTION

Idle speed may be higher during warming up of engine. If shifted to Forward or Reverse during warming up, it may be difficult to shift back to neutral. In such case, stop engine, shift to neutral, and restart engine to warm up.

ENON00014-0

#### Note

Frequent shifting to forward or reverse can accelerate wear or degradation of parts. In such case, replace gear oil earlier than the period specified.

ENOW00864-0

#### CAUTION

Do not increase engine speed unnecessarily when the shift is in neutral and reverse, or engine damage may occur.

ENOM00890-A

**Tiller handle type**

ENOW00865-A

**⚠ CAUTION**

Do not force to shift when the throttle grip is not in the fully closed position, otherwise, steering system and/or shifting mechanism may be damaged.

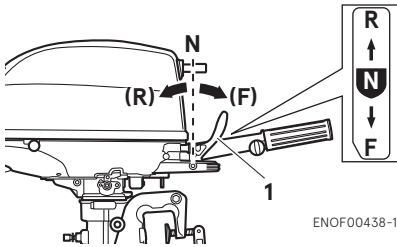

ENOF00438-1

1. Shift lever

**Forward**

1. Turn the throttle grip to reduce engine speed.
2. When the engine reaches trolling (or idling) speed, quickly pull the shift lever to the Forward position.

**Reverse**

1. Turn the throttle grip to reduce engine speed.
2. When the engine reaches trolling (or idling) speed, quickly pull the shift lever to the Reverse position.

**Acceleration**

ENOW00867-0

**⚠ WARNING**

Sudden acceleration and deceleration may cause passenger(s) to be thrown overboard or falling down.

Open throttle grip gradually.

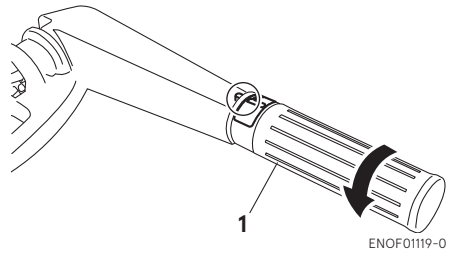

1. Throttle grip

ENOM00049-A

**5. Stopping the engine**

ENOW00868-0

**⚠ WARNING**

Be careful not to remove engine stop switch lanyard from engine accidentally while boat is running. Sudden stop of engine can cause loss of steering control. It can also cause loss of boat speed, possibly leading the crew(s) and or objects on the boat to be thrown forward due to inertial force.

**Tiller handle type**

1. Turn the throttle grip to the slow position.

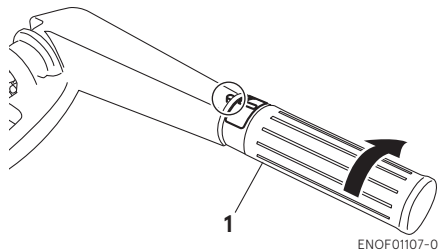

1. Throttle grip
2. Put the shift lever in the Neutral position.

Run the engine for 2-3 minutes at idling speed for cooling down if it has been running at full speed.

3. Push the stop switch.

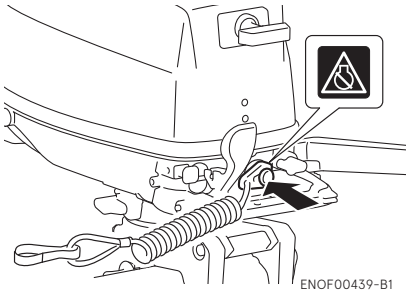

ENOW00869-0

**WARNING**

After stopping the engine:

- Close the air vent screw on the fuel tank cap.
- Disconnect the fuel connector of the engine and the fuel tank.
- Disconnect the battery cord, after each use.

7

**Emergency engine stopping**

Remove stop switch lock to stop the engine.

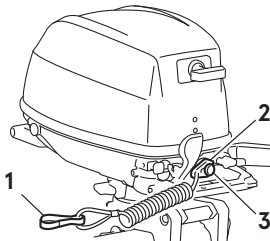

1. Hock
2. Stop switch lock
3. Stop switch

ENOM00910-0

**Spare emergency stop switch lock**

A spare emergency stop switch lock is

provided in the tool bag.

When used as described, the emergency stop switch clip and emergency stop switch lanyard system stops the engine if the operator falls away from the controls. When an operator falls into water, be sure to use emergency stop switch lock of the spare.

Be sure to confirm the spare stop switch lock is in the tool bag before begin to operate.

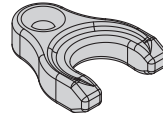

ENOF00891-0

ENOM00920-A

**6. Steering**

ENOW00870-0

**WARNING**

**Sudden steering may cause passenger(s) to be thrown overboard or falling down.**

**Tiller handle type**

**Right turn**

Move the tiller handle to the left

**Left turn**

Move the tiller handle to the right.





ENOM00050-0

## 7. Trim angle

ENOW00043-A

### WARNING

- Adjust the trim angle when the engine is stopped.
- Do not put hand or finger in between outboard motor body and clamp bracket when adjusting trim angle to prevent injury in case the outboard motor body falls.
- Unsuitable trim position can cause loss of control of boat. When testing a trim position, run boat slow initially to see if it can be controlled safely.

ENOW00044-0

### WARNING

Excessive trim up or down may lead to unstable boat operation, potentially causing the steering difficulty that leads to accident during cruising.

- Do not cruise at high speed if improper trim position is suspected. Stop the boat and readjust trim angle before continuing cruise.
- For outboard motor model with PTT switch on the bottom cowl, do not operate the switch during cruising, or control of boat may be lost.

The trim angle of the outboard motor can be adjusted to suit the transom angle of the hull, and load conditions. Choose an appropriate trim angle that will allow the anti-ventilation plate to run parallel to the water surface during operation.

ENOM00052-0

### Proper trim angle

The position of the thrust rod is correct if the hull is horizontal during operation.

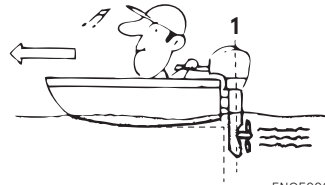

ENOF00051-1

1. Perpendicular to the water surface

ENOM00053-A

### Improper trim angle (bow rises too high)

Set the thrust rod (or preset knob) lower if the bow of the boat rises above horizontal.



ENOF00052-0

ENOM00054-0

### Improper trim angle (bow dips into the water)

Set the thrust rod (or preset knob) higher if the bow of the boat is below horizontal.



ENOF00053-0

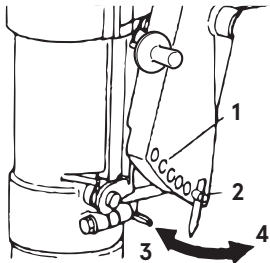

ENOF00440-0

7

1. Trim angle adjustment hole
2. Thrust rod
3. Higher
4. Lower

**Trim angle adjustment (Manual tilt type)**

The transom angle adjustment

1. Stop the engine.
2. Shift into neutral position.
3. Tilt up the outboard motor.
4. Remove the thrust rod as shown picture.

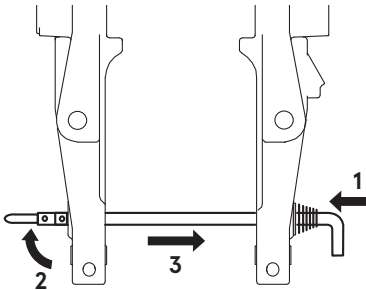

ENOF01238-1

1. Push in
2. Rise the stopper
3. Pull out

5. Reinstall the thrust rod in the desired position securely.
6. Gently tilt down the outboard motor.

ENOM00060-A

**8. Tilt up and down**

ENOW00055-0

**! WARNING**

Do not tilt up or down outboard motor when swimmer(s) or passenger is near to prevent them from being caught between outboard motor body and clamp bracket in case the outboard motor body falls.

ENOW00048-0

**! WARNING**

When tilting up or down, be careful not to place your hand between the swivel bracket and the stern bracket.

Be sure to tilt the outboard motor down slowly.

ENOW00056-A

**! WARNING**

When tilting up outboard motor with fuel joint for over a few minutes, be sure to disconnect fuel hose, or fuel may leak, potentially catching fire.

ENOW00057-0

**! CAUTION**

Do not tilt up outboard motor while engine operates, or no cooling water may be fed, leading to engine seizure due to overheating.

ENON00921-0

**Note**

Before tilting the outboard motor up, after stopping the motor leave it in the running position for about a minute to allow water to drain from inside the engine.

ENOM00423-0

**Tilt up**

With the shift lever in Forward, fully tilt the motor up toward you by holding the tilt handle provided at the rear of the top cowl. Then slightly lower the motor for locking in the up position.

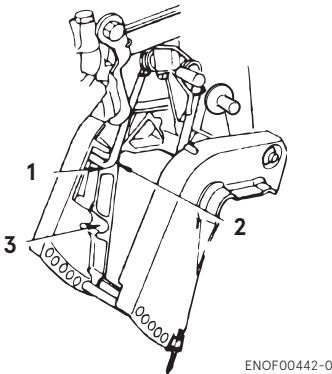
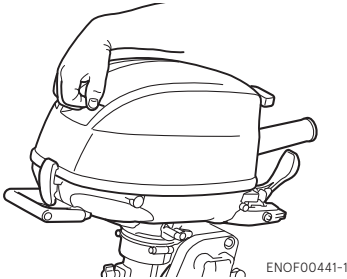

- 1. Tilt up position
- 2. Tilt stopper
- 3. Shallow water running position

ENOM00424-0

**Tilt down**

Slightly tilt the motor up, and pull the tilt lever toward you to release the tilt-lock. Then lower the motor slowly.

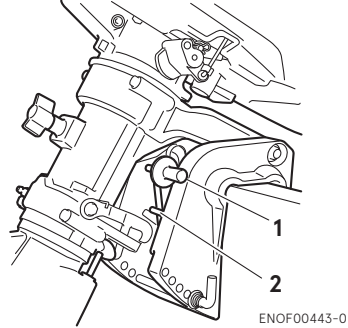

- 1. Tilt lever
- 2. Tilt stopper

ENOM00068-A

**9. Shallow water operation**

ENOW00051-0

**⚠ WARNING**

During shallow water operation, be careful not to place your hand between the swivel bracket and the clamp bracket. Be sure to tilt the outboard motor down slowly.

ENOW00053-0

**⚠ CAUTION**

While in shallow water drive position, do not operate the outboard motor in Reverse. Operate the outboard motor at slow speed and keep the cooling water intake submerged.

ENOW00054-A

 **CAUTION**

Do not overtilt outboard motor when driving shallow water, or air may be sucked through water inlet, potentially leading to engine overheating.

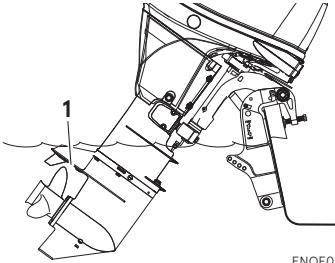

ENOF01144-A

1. Water inlet

## 7

**Manual tilt type****Shallow water running position:**

1. With the shift lever in Forward, tilt the motor up slowly by about 40° and then lower the tilt lever for setting at the shallow water running position.

**Return to normal running position:**

2. Tilt the motor up fully and then return the motor down slowly to the normal running position.

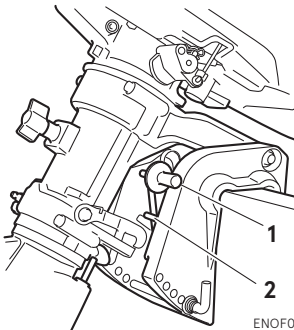

ENOF00443-0

1. Tilt lever
2. Tilt stopper

# REMOVING AND CARRYING THE OUTBOARD MOTOR

ENOM00070-K

## 1. Removing the outboard motor

ENOW00064-0

### CAUTION

Engine may be hot immediately after operating and could cause burns if touched. Allow engine to cool down before attempting to carry the outboard.

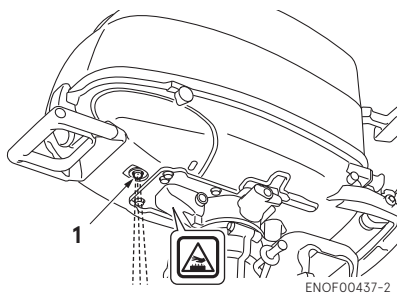

ENOF00437-2

1. Cooling water check port
1. Stop the engine.
2. Disconnect the fuel connector, the remote control cables and the battery cords from the outboard motor.
3. Remove the outboard motor from boat and completely drain the water from the gear case in a vertical position.

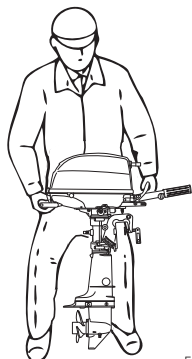

ENOF01505-1

ENOM00071-A

## 2. Carrying the outboard motor

ENOW00933-0

### WARNING

Be sure to disconnect fuel connector except when operating engine.

Fuel leakage is a fire or explosion hazard, which can cause serious injury or death.

ENOW00065-0

### WARNING

Close air vent screw of fuel tank before carrying or storing outboard motor and fuel tank, or fuel may leak, potentially catching fire.

ENOW00066-C

### CAUTION

- Do not give a shock to an outboard motor during transportation. It becomes a cause of breakage.
- Do not carry or store outboard motor in any of positions described below. Otherwise, engine oil or cooling water may enter the cylinder cause engine problems. Property damage could result from leaking oil out.

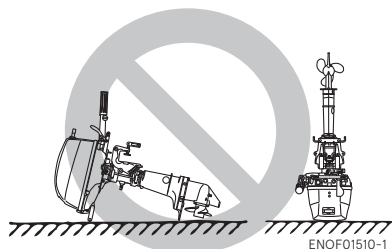

ENOF01510-1

Keep the outboard motor in a vertical position when carrying.

The optional outboard motor stand is recommended for keeping the outboard motor vertical both during transport and storage.

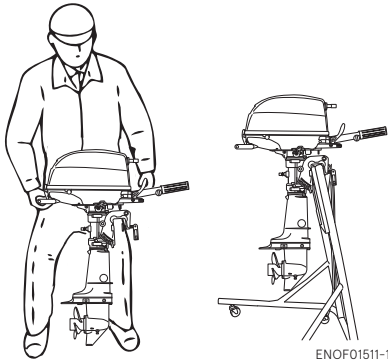

ENOM00441-0  
If the outboard motor must be laid down, be sure to drain the remaining fuel in the fuel line and carburetor (see page 65). When laying down the outboard motor, place front-side, starboard-side, or port-side down on a cushion or any softer surface shown below.

8

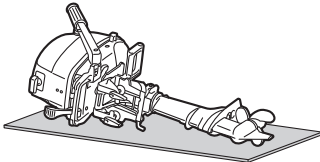
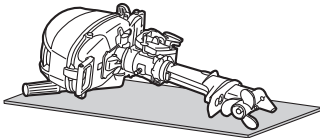

ENOF01532-0

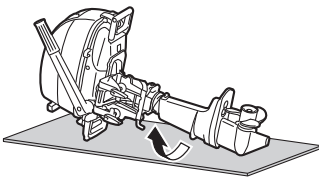

ENOF01533-0

ENON00941-0

**Note**

When laying the outboard front-side down, turn the clamp bracket 90° clockwise or anti-clockwise so that it does not interfere with the ground. Then tighten up the steering adjustment screw to maintain its position (see page 48).

ENOM00072-A

**3. Trailering**

ENOW00072-0



**Trailering in the tilted position may cause damage to the outboard motor, boat, etc.**

ENOW00073-A



**Be sure to disconnect fuel connector except when operating engine. Fuel leakage is a fire or explosion hazard, which can cause serious injury or death.**

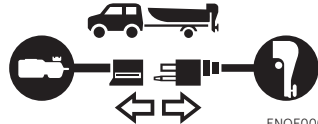

ENOF00075-1

ENOW00068-0



**Close air vent screw of fuel tank and fuel cock before carrying or storing outboard motor and fuel tank, or fuel may leak, potentially catching fire.**

ENOW00071-0



**The tilt support device supplied on your outboard motor is not intended for towing. It is**

intended to support the outboard motor while the boat is docked, beached, etc.

ENOW00072-A

### ⚠ CAUTION

When trailering the outboard motor should be in a vertical (normal running) position, fully down. Trailering in the tilted position may cause damage to the outboard motor, boat, etc.

If trailering with outboard motor fully down is not available (the gear case skeg is too close to the road in a vertical position), fix the outboard motor securely using a device (like a transom saver bar) in the tilted position.

When transporting a boat on a trailer with the outboard motor still attached, disconnect the fuel line from the outboard motor beforehand and keep the outboard motor in the normal running position or on a transom saver bar.

### Tiller handle type

To prevent the outboard motor from moving when it is attached on a boat during transport on a trailer, properly tighten the steering friction adjustment screw (page 48).

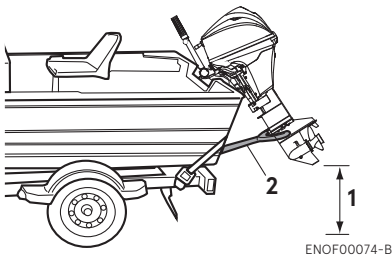

ENOF00074-B

1. Ground clearance should be provided sufficiently.
2. Transom saver bar

ENOW00067-0

### ⚠ WARNING

Do not go under outboard motor tilted up even if it is supported by support bar, or accidental fall of outboard motor could lead to severe personal injury.

# ADJUSTMENT

ENOM00073-0

## 1. Steering friction

### Tiller handle type

ENOW00074-E

#### WARNING

**Do not overtighten the steering friction adjustment screw it could result in difficulty of movement resulting in the loss of control causing an accident and could lead to severe injury.**

ENON00506-0

#### Note

The steering friction adjustment screw is used to adjust the friction load of the steering, but not to fix the steering. Excess tightening of the adjustment screw may cause damage to the swivel bracket.

ENOM00544-0

Steering friction can be adjusted in accordance with your preference by turning the steering friction adjustment screw.

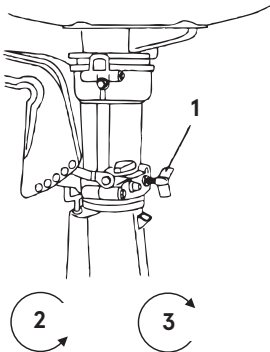

ENOF00444-0

1. Steering friction adjustment screw
2. Lighter
3. Heavier

EENOM00074-A

## 2. Throttle grip friction

ENOW00074-B

#### WARNING

**Do not overtighten the throttle adjustment screw or it could result in difficulty of movement resulting in the loss of control causing an accident and could lead to severe injury.**

Friction adjustment of the throttle grip can be made with the throttle adjustment screw.

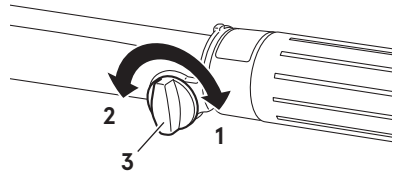

ENOF00445-A

1. Heavier
2. Lighter
3. Throttle friction adjustment screw



# INSPECTION AND MAINTENANCE

ENOM00077-0

## Care of your outboard motor

To keep your outboard motor in the best operating condition, it is very important that you perform daily and periodic maintenance as suggested in the maintenance schedules that follow.

ENOW00077-0

### CAUTION

- **Your personal safety and that of your passengers depends on how well you maintain your outboard motor. Carefully observe all of the inspection and maintenance procedures described in this section.**
  - **The maintenance intervals shown in the checklist apply to an outboard motor in normal use. If you use your outboard motor under severe conditions such as frequent full-throttle operation, frequent operation in brackish water, or for commercial use, maintenance should be performed at shorter intervals. If in doubt, consult your dealer for advice.**
  - **We strongly recommend that you use only genuine replacement parts on your outboard motor. Damage to your outboard motor arising from the use of other than genuine parts is not covered under the warranty.**
-

ENOM00428-0

## 1. Daily Inspection

Perform the following checks before and after use.

ENOW00078-1

### WARNING

**Do not use outboard motor if any abnormality is found during pre-operation check otherwise it could result in severe damage to the motor or severe personal injury.**

Item	Points to Check	Remedy
<b>Fuel System</b>	<ul style="list-style-type: none"> <li>Check the amount of fuel in the tank.</li> <li>Check for debris or water in the fuel filters.</li> <li>Check the rubber hoses for fuel leakage.</li> </ul>	Replenish Clean or replace Replace
<b>Fuel Tank and Cap</b>	<ul style="list-style-type: none"> <li>Check for crack, leakage, damage in the fuel tank and cap.</li> <li>Check for crack, damage in the gasket and tether.</li> <li>Check for leakage at full close.</li> <li>Check for ratchet performance.</li> </ul>	Replace Replace Replace Replace
<b>Engine Oil</b>	<ul style="list-style-type: none"> <li>Check the oil level.</li> </ul>	Fill to the upper level mark on dipstick
<b>Electrical Equipment</b>	<ul style="list-style-type: none"> <li>Check that the main switch functions normally.</li> <li>Check that the battery electrolyte level and specific gravity are normal.</li> <li>Check for loose connections on the battery terminal.</li> <li>Check that the stop switch functions normally and make sure the lock plate is there.</li> <li>Check cords for loose connections and damage.</li> <li>Check the spark plugs for dirt, wear and carbon build-up.</li> </ul>	Replace Replenish or recharge Retighten Remedy or replace Correct or replace Clean or replace
<b>Throttle System</b>	<ul style="list-style-type: none"> <li>Check carburetor linkage is working normally when turning the throttle grip.</li> </ul>	Correct
<b>Recoil Starter</b>	<ul style="list-style-type: none"> <li>Check the rope for wear and chafing.</li> <li>Check the ratchet engagement.</li> </ul>	Replace Correct or replace
<b>Clutch and Propeller System</b>	<ul style="list-style-type: none"> <li>Check that clutch engages correctly when operating the shift lever.</li> <li>Visually Check propeller for bent or damaged blades.</li> <li>Check the propeller nut is tightened and the split pin is present.</li> </ul>	Adjust Replace
<b>Installation of Motor</b>	<ul style="list-style-type: none"> <li>Check all the bolts attaching the motor to the boat.</li> <li>Check the thrust rod installation.</li> </ul>	Tighten
<b>Cooling Water</b>	<ul style="list-style-type: none"> <li>Check that cooling water is discharged from the cooling water check port after the engine has started.</li> </ul>	Repair
<b>Tools and Spares</b>	<ul style="list-style-type: none"> <li>Check that there are tools and spare parts for replacing spark plugs, the propeller, etc.</li> <li>Check that you have the spare rope.</li> </ul>	
<b>Steering Devices</b>	<ul style="list-style-type: none"> <li>Check the operation of the steering handle.</li> </ul>	Repair
<b>Other parts</b>	<ul style="list-style-type: none"> <li>Check if the anode is securely installed.</li> <li>Check the anode for corrosion and deformation.</li> </ul>	Repair if necessary Replace

ENOM00081-B

## Oil level checking

1. Place the engine in a vertical position.
2. Remove the top cowl and the oil filler cap (dipstick).
3. Wipe oil off the dipstick with a clean cloth and screw the dipstick back completely.
4. Remove the dipstick again. Check the oil level on the dipstick. Oil level must be between the upper limit and lower limit shown on the dipstick.
5. Return the dipstick.

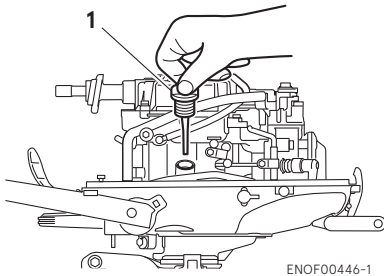

1. Oil filler cap (Dipstick)



1. Upper limit
2. Lower limit

ENON00024-0

### Note

The oil level should be checked when the engine is cooled.

ENON00025-0

## Note

Consult with an authorized dealer if the engine oil is milky color, or appears contaminated.

ENOM00082-A

## Engine oil replenishing

ENOW00079-A

### ⚠ CAUTION

- Do not add engine oil of brand and grade other than existing one. In case engine oil of other brand or grade is added, drain all oil and ask dealer for treatment.
- In case other than engine oil such as gasoline is put in the oil chamber, empty the chamber and ask dealer for treatment.
- When replenishing engine oil, be careful not to allow entry of foreign matters such as dust and water into oil chamber.
- Wipe off engine oil well immediately if spilled and dispose of it in accordance with local fire prevention and environment protection regulations.
- Do not replenish engine oil over upper limit. If overfilled, remove oil to upper limit. If engine oil is over the upper limit, it can leak potentially leading to engine damage.

If the oil level is low, or at lowest mark, add recommended oil to the middle dipstick mark.

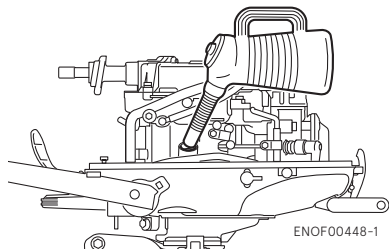

ENOM00083-B

### Washing outboard motor

ENOW00081-0

**WARNING**

Do not start engine without removing propeller, or accidentally turning propeller could cause personal injury.

ENOW00082-0

**WARNING**

Never start or operate the engine indoors or in any space which is not well ventilated. Exhaust gas contains carbon monoxide, a colorless and odorless gas which can be fatal if inhaled for any length of time.

ENOW00920-0

**CAUTION**

When washing the outboard motor, be careful not to spray the water inside of the top cowl, especially electrical components.

ENON00026-0

**Note**

It is recommended to check chemical properties of water on which your outboard motor is regularly used.

10

If outboard motor is used in salt water, brackish water or water with a high acidic level, use fresh water to remove salt, chemicals or mud. And flush cooling water passage after every cruising or before storing outboard motor for long time. Before flushing, remove the propeller and the forward thrust holder.

ENOM00085-A

### Flushing attachment

ENOW00922-0

**CAUTION**

To prevent the engine from starting when you are near the propeller, remove the stop switch lock.

1. Tilt down the outboard motor.
2. Remove the water plug from the gear case, and screw in the flushing attachment.
3. Connect a water hose. Turn on the water and adjust the flow (Be sure to seal the water inlet, located in the gear case with tape).
4. Put the shift lever in the neutral position and start the engine. Continue flushing the outboard motor for 3 to 5 minutes at idling.
5. Stop the engine and water supply. Remove the flushing attachment and tape. After the flushing, be sure to reattach the water plug.

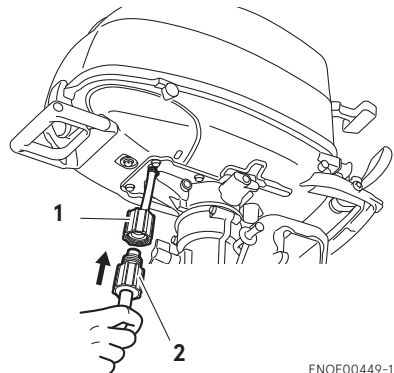

FNOF00449-1

1. Flushing attachment (option)
2. Garden hose (commercial available)

ENOM00085-A

**Flushing by test tank**

ENOW00081-0

**⚠ WARNING**

Do not start engine without removing propeller, or accidentally turning propeller could cause personal injury.

ENOW00082-0

**⚠ WARNING**

Never start or operate the engine indoors or in any space which is not well ventilated. Exhaust gas contains carbon monoxide, a colorless and odorless gas which can be fatal if inhaled for any length of time.

ENOW00036-A

**⚠ CAUTION**

When the engine is started in the test tank, to avoid over heating and water pump damage, be sure the water level is at least 10 cm (4 in.) above the anti ventilation plate.

And be sure to remove the propeller, when starting the engine in the test tank. (See page 59)

Run the engine only at idling.

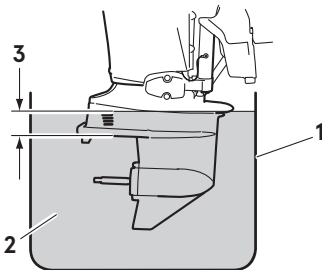

ENOF00863-0

1. Test tank
2. Water
3. Over 10 cm (4 in.)

ENOM00950-0

**Fuse replacement (for SP type)**

ENOW00923-0

**⚠ CAUTION**

Before replacing a fuse, disconnect the battery cable from the battery negative (-) terminal. Failure to do so may cause a short-circuit.

ENOW00924-0

**⚠ CAUTION**

Never use a fuse with a rating that exceeds the specified rating as this could cause serious damage to the electrical system.

If a blown fuse is detected, try to determine the cause for this and correct it. If the cause for the problem is not corrected, the fuse will likely blow again.

If the fuse continues to blow, request an authorized Tohatsu dealer to inspect the outboard motor.

1. Stop the engine and disconnect the battery cable from the battery negative (-) terminal.
2. Remove the engine cover.
3. Remove the fuse box lid.

4. Remove the fuse and check it. If the fuse is blown, replace it with a fuse of the same specified rating. The outboard motor is supplied with spare fuses in the spare fuse holder.

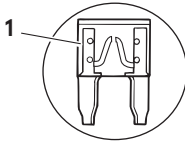
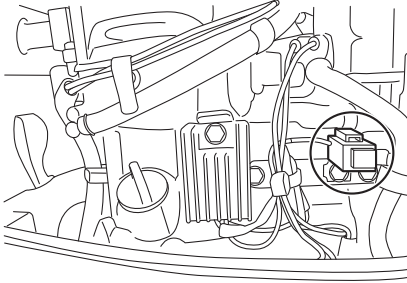

ENOF01524-0

1. Blown fuse

ENOM00431-0

## 2. Periodic Inspection

It is important to inspect and maintain your outboard motor regularly. At each interval on the chart below, be sure to perform the indicated servicing. Maintenance intervals should be determined according to the number of hours or number of months, whichever comes first.

Description		Inspection intervals				Inspection procedure	Remarks
		First 20 hours of 1 month	Every 50 hours of 3 months	Every 100 hours of 6 months	Every 200 hours of 1 year		
Fuel System	Carburetor <sup>*1</sup>			●	●	Strip, Clean, and adjust.	
	Fuel filter	●	●	●	●	Check and clean or Replace if necessary.	Entire cartridge
	Piping/Hoses <sup>*2</sup>	●	●	●	●	Check and clean or Replace if necessary.	
	Fuel tank <sup>*2</sup>	●		●	●	Clean	
	Fuel tank cap <sup>*2</sup>	●	●	●	●	Check and clean or Replace if necessary.	
	Fuel pump <sup>*1</sup>	●	●	●	●	Check and clean or Replace if necessary.	Disassemble and check each 300 hours.
Ignition	Spark plug	●		●	●	Check gaps. Remove carbon deposits or Replace if necessary.	0.8–0.9 mm (0.031–0.035 in)
	Ignition timing <sup>*1</sup>	●		●	●	Check timing.	
Starting System	Starter rope	●	●	●	●	Check for wear or chafing.	
Engine	Engine oil	Replace ●		Replace ●	Replace ●	Replace if necessary.	
	Valve Clearance <sup>*1</sup>	●		●	●	Check & adjust.	IN: 0.06–0.14 mm (0.0024–0.0055 in) EX: 0.11–0.19 mm (0.0043–0.0075 in)
	Thermostat <sup>*1</sup>			●	●	Check and Replace if necessary.	
Lower Unit	Propeller	●	●	●	●	Check for bent blades, damage, wear.	
	Gear oil	Replace ●	●	Replace ●	Replace ●	Change or replenish-oil and check for water leaks.	195 mL (6.6 fl.oz)
	Water pump <sup>*1</sup>		●	●	●	Check for wear or damage.	Replace impeller every 12 months.
Warning System <sup>*1</sup>			●	●	●	Check function.	
Bolts and Nuts		●	●	●	●	Retighten	
Sliding and Rotating Parts. Grease Nipples		●	●	●	●	Apply and pump in grease.	
Outer Equipment		●	●	●	●	Check for corrosion.	
Anode			●	●	●	Check for corrosion and deformation.	Replace if necessary.

\*1: Have this handled by your dealer.

\*2: In USA, you have to use EPA approved part.

ENON00030-0

**Note**

Your outboard motor should receive careful, and complete inspection at 300 hours. This is the best time for major maintenance procedures to be carried out.

ENOM00091-B

**Engine oil replacement**

ENOW00091-0

**⚠ CAUTION**

You may be injured due to high engine temperatures if you fill engine oil just after stopping. Changing engine oil should be done after the engine has been cooled.

ENOW00092-A

**⚠ CAUTION**

- Do not overfill engine oil, or engine oil could leak and/or engine could be damaged. If engine oil level is over upper limit marks of oil gauge, drain oil to level lower than upper limit.
- Be sure that outboard motor is in upright and level position when checking or changing oil.
- Stop engine immediately if low oil pressure warning lamp is lit or oil leak is found, or engine could be severely damaged. Consult dealer.
- Wipe off engine oil well immediately if spilled and dispose of it in accordance with local fire prevention and environment protection regulations.

ENOW00090-0

**⚠ CAUTION**

Use of engine oils that do not meet these requirements will result in reduced engine life, and other engine problems.

ENOW00933-0

**⚠ CAUTION**

Engine oil mixed with dust or water will dramatically shorten the life of the engine.

**To change engine oil:**

- Be sure to use recommended engine oil.
1. Stop the engine and allow it to cool.
  2. Turn the steering on the outboard motor left.
  3. Put a oil drain pan under the oil drain screw.
  4. Remove the oil drain screw and completely drain oil from the engine.

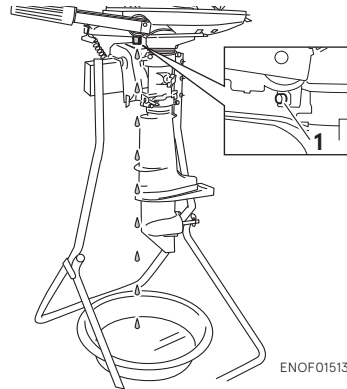

ENOF01513-0

1. Drain hole
5. Tighten the oil drain screw with applying oil on the sealing surface of screw. (Use new oil drain washer)

Oil drain screw specified torque

**18Nm (13 ft-lb, 1.8 kgf-m)**

6. Remove the top cowl and the oil filler cap.



- Fill the engine through filler port with recommended oil to the middle of dipstick mark.
- Tighten the oil filler cap (dipstick).

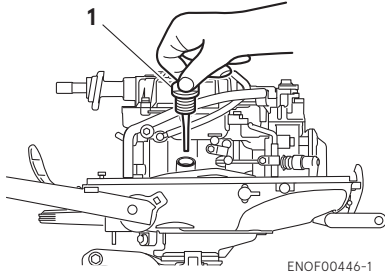

- Oil filler cap (Dipstick)

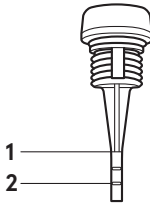

- Upper limit
- Lower limit

ENON00920-0

**Note**

Use only recommended engine oil (See page 27)

**Oil volume needed for complete oil replacement**

Approximately 450 mL (0.48 US qt.)

ENOW00925-0

**CAUTION**

**Wipe off engine oil well immediately if spilled and dispose of it in accordance with local fire prevention and environment protection regulations.**

ENON00031-0

**Note**

- If any amount of water is found in engine oil, making it milky white, consult dealer.
- If engine oil is contaminated with fuel, emitting strong fuel smell, consult dealer.
- Some oil dilution is normal if engine is idled or trolled for long periods, especially in cooler water temperatures.

ENOM00093-A

**Fuel filters and fuel tank cleaning**

ENOW00093-A

**WARNING**

**Gasoline and its vapors are very flammable and can be explosive.**

- Do not start this procedure while engine is operating or hot even after stopping it.**
- Place fuel filter away from every source of ignition such as sparks or open flames.**
- Wipe off gasoline well immediately if spilled and dispose of it in accordance with local fire prevention and environment protection regulations.**
- Install fuel filter with all related parts in place, or fuel leak could occur, leading to catching fire or explosion.**
- Check fuel system regularly for leakage.**
- Contact authorized dealer for fuel system services. Services by unqualified person could lead to engine damage.**

Fuel filters are provided inside the fuel tank and engine.

ENOM00094-0

**Fuel filter (for engine)**

- Replace the fuel filter provided inside of engine cover if there is water or dirt inside.

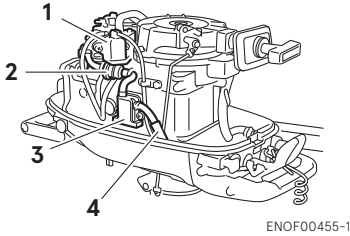

- 1. Carburetor
- 2. Fuel filter
- 3. Fuel pump
- 4. Fuel pipe

ENOM00096-A

### Fuel filter (for fuel tank)

Water or dirt in the fuel tank will cause engine performance problems.

Check and clean the tank at specified times or after the outboard motor has been stored for a long period of time (over three months).

1. Remove the fuel pickup elbow of the fuel tank by turning it counterclockwise
2. Clean the fuel filter and check the O-ring. Replace it if necessary.
3. Reassemble all parts.

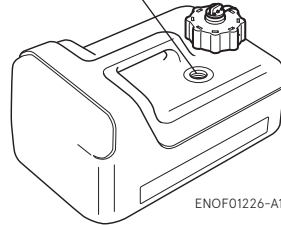
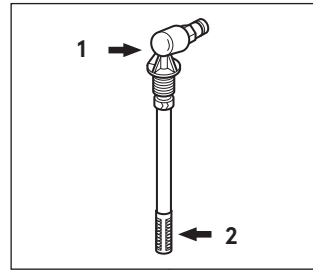

- 1. Fuel pick up
- 2. Filter

ENOM00098-A

### Gear oil replacement

ENOW00094-0

**⚠ WARNING**

- Be sure that outboard motor is secured to transom or service stand, or accidental drop or fall of outboard motor could lead to severe personal injury.
- Be sure to lock outboard motor if it is tilted up, or accidental fall of outboard motor could lead to severe personal injury.
- Do not go under outboard motor tilted up and locked, or accidental fall of outboard motor could lead to severe personal injury.

1. Tilt down the outboard motor.
2. Remove the oil plugs (lower and upper), and completely drain the gear oil into a pan.

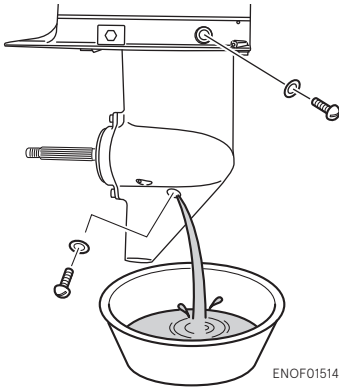

ENOF01514-0

3. Insert the oil tube nozzle into the lower oil plug hole, and fill with gear oil by squeezing the oil tube until oil flows out of the upper plug hole and bubbles is disappeared to remove the air.

ENON00033-0

### Note

Use genuine gear oil or the recommended one (API GL-5; SAE #80 to #90).  
Required volume: approx. 195 mL (6.6 fl.Oz).

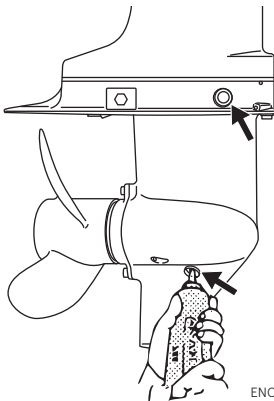

ENOF01515-0

4. Install the upper oil plug, and then remove oil tube nozzle and install the lower oil plug.

Oil plug specified tightening torque  
**4Nm (3 ft-lb, 0.4 kgf-m)**

ENOW00095-0

### ⚠ CAUTION

Do not reuse oil plug gasket. Always use new gasket and tighten oil plug properly to prevent entry of water into lower unit.

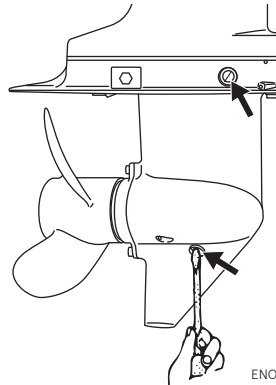

ENOF01516-0

ENOW00928-0

### ⚠ CAUTION

Wipe off gear oil well immediately if spilled and dispose of it in accordance with local fire prevention and environment protection regulations.

ENON00032-0

### Note

If water in the oil, giving it a milky colored appearance. Contact your dealer.

ENOM00086-A

## Propeller replacement

ENOW00084-0

### ⚠ WARNING

- Do not begin propeller removal and installation procedure with spark plug caps attached, shift in forward or reverse, main switch at other than "OFF", engine

stop switch lock attached to the switch, and starter key attached, or engine could accidentally start leading to serious personal injury. Disconnect battery cable if possible.

- The propeller edge is thin and sharp. Wear the groves during replacement to protect your hands.

ENOW00086-0

**CAUTION**

- Do not install propeller without thrust holder, or propeller boss could be damaged.
- Do not reuse split pin.
- After installing split pin, spread the pin apart to prevent it from falling out which could lead to the propeller coming off during operation.

A worn-out or bent propeller will lower the motor's performance, and cause engine trouble.

1. Put a piece of wood block between propeller blade and anti-ventilation plate to hold propeller.

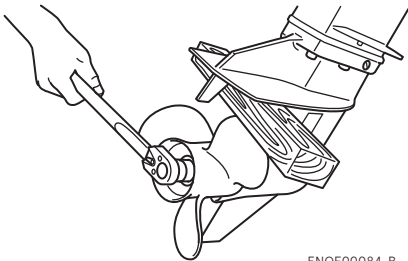

2. Remove the split pin, propeller nut and washer.
3. Remove the propeller and thrust holder.

4. Apply water proof grease to the propeller shaft before installing a new propeller.
5. Install the thrust holder, propeller, stopper, washer and propeller nut onto the shaft.

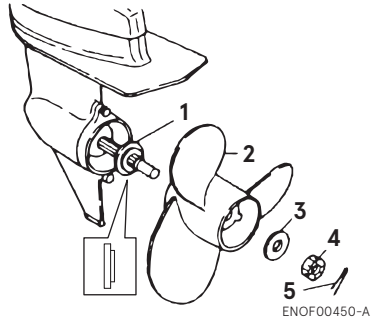

1. Thrust holder
  2. Propeller
  3. Washer
  4. Propeller nut
  5. Split pin
6. Tighten the propeller nut to specified torque, and align one of grooves to propeller shaft hole.

Propeller nut torque:  
**12 Nm (9 ft-lb, 1.2 kgf-m)**

7. Install a new split pin into the nut hole and bend it.

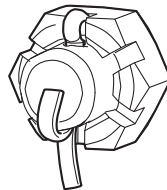

ENOM00087-A

**Spark plugs replacement**

ENOW00087-0

**WARNING**

- Do not reuse spark plug with damaged insulation, or sparks can leak through crack, potentially leading to electric shock, explosion and/or fire.
- Do not touch spark plugs immediately after stopping engine as they will be hot and could cause severe burns if touched. Allow motor to cool down first.

ENOW00929-0

**CAUTION**

**Use only the recommended spark plugs. Spark plugs which have an different heat range may cause engine damage.**

If the spark plug(s) is fouled, has carbon build up, or is worn, it should be replaced.

When reusing spark plugs, remove dirt from the electrodes and adjust spark gap to specification.

1. Stop the engine.
2. Remove the top cowl.
3. Remove the spark plug caps.
4. Remove the spark plugs by turning it counter-clockwise, using a 5/8" (16 mm) socket wrench and handle that is provided in tool bag.
5. Inspect the spark plug. Replace the spark plug if the electrodes are worn or if the insulators are cracked or chipped.

6. Measure the spark plug electrode gap with a wire type feeler gauge. The gap should be 0.8-0.9 mm (0.031-0.035 inches). If the gap is different, replace the spark plug with a new one. Use spark plug NGK DCPR-6E.

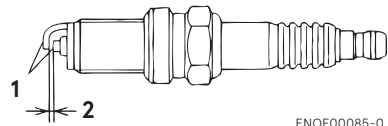

ENOF00085-0

1. Electrode
  2. Spark gap (0.8-0.9 mm, 0.031-0.035 in)
7. Install the spark plug by hand and turn it carefully to avoid cross-threading.
  8. Tighten the spark plug to the specified torque.

ENON00028-0

**Note**

- **Spark plug torque:**  
**18.0 Nm (13.3 ft-lb) [1.84 kgf-m]**

If a torque-wrench is not available when you are fitting a spark plug, a good estimate of the correct torque is 1/4 to 1/2 a turn past finger-tight. Have the spark plug adjusted to the correct torque as soon as possible with a torque-wrench.

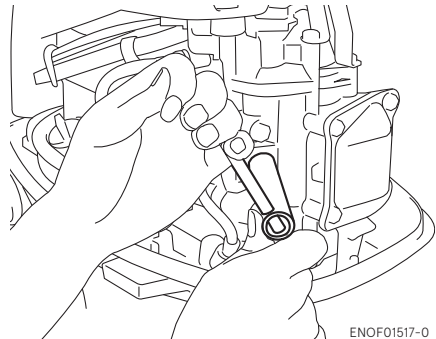

ENOF01517-0

ENOM00088-B

## Anode replacement

A sacrificial anode protects the outboard motor from electrolytic corrosion. Anode is located on the gear case, etc.. When the anode is eroded more than 1/3 of original size, replace it.

ENON00029-0

### Notes

- Never grease or paint the anode.
- At each inspection re-tighten the anode attaching bolt. As it is likely to be subjected to electrolytic corrosion.

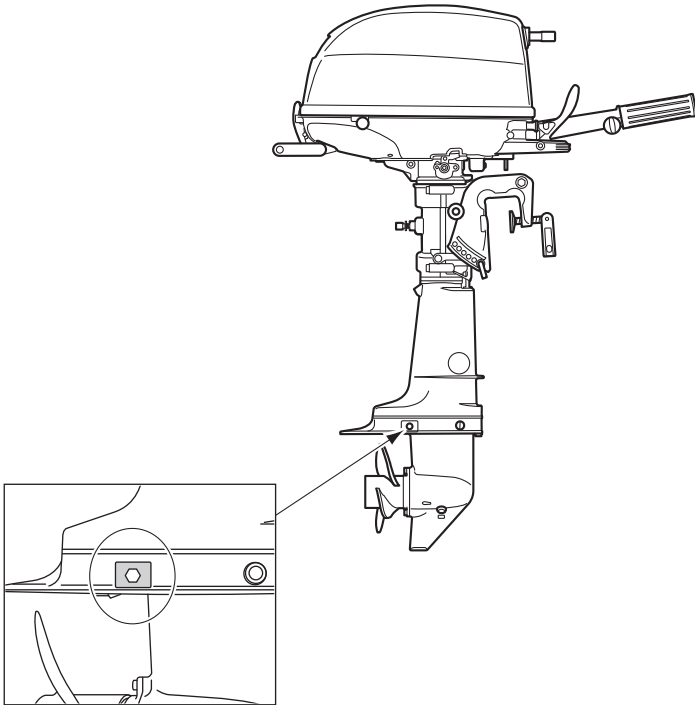

ENOM00960-0

**Grease point**

Apply water proof grease to the parts shown below.

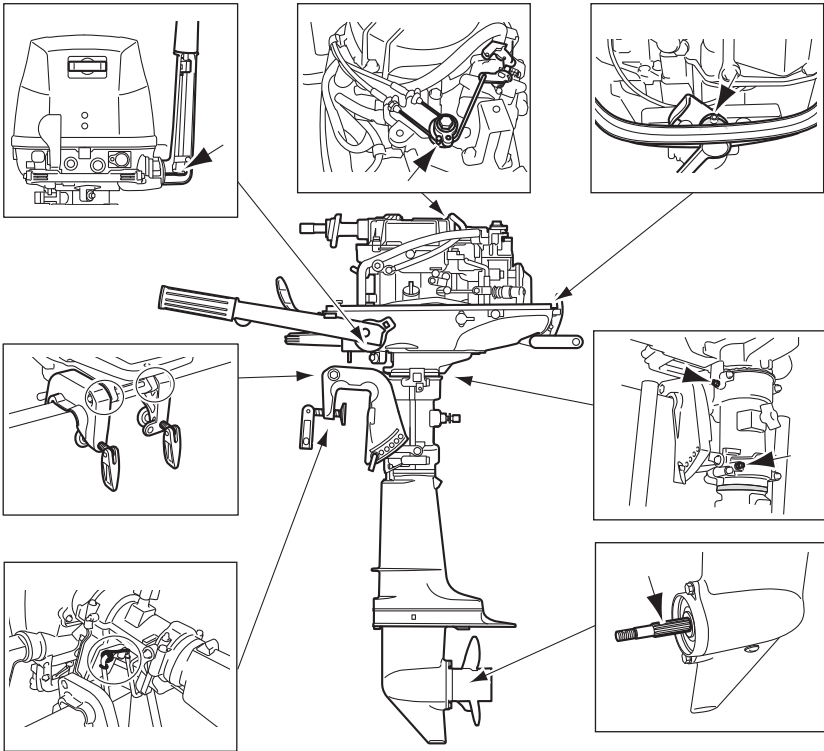

ENOM00100-A

### 3. Off-season storage

ENOW00934-0

#### ⚠ WARNING

- Be sure to disconnect fuel connector except when operating engine.
- Fuel leakage is a fire or explosion hazard, which can cause serious injury or death.

ENOW00097-0

#### ⚠ WARNING

Be sure to use cloth to remove fuel remaining in the cowl and dispose of it in accordance with local fire prevention and environment protection regulations.

Before you put your outboard motor in storage, it is a good opportunity to have it serviced and prepared by your dealer. Be sure to use fuel stabilizer while running the motor before storage. (See page 65)

ENOM00101-A

#### Engine

1. Wash the engine exterior and flush the cooling water system thoroughly with fresh water. Drain the water completely. Wipe off any surface water with an oily rag.
2. Remove the fuel hose from the outboard motor.
3. Drain all fuel from the fuel hoses, fuel pump and carburetor (See page 65), and clean these parts. Keep in mind that if gasoline is kept in the carburetor for a long time, gum and varnish will develop, causing the float valve to stick, restricting the fuel flow.

4. Remove the spark plugs and put a teaspoon of engine oil or spray storage oil into the combustion chamber through the spark plug holes.
5. Pull the recoil starter several turns to lubricate inside the cylinder.

ENOW00930-0

#### ⚠ WARNING

- Be sure to remove stop switch lock to prevent ignited the spark plugs.
  - Put a cloth to spark plug hole and wipe up any spilled engine oil, when cranking the outboard motor.
6. Change the engine oil (See page 56).
  7. Change the gear oil in the gear case (See page 58).
  8. Apply grease to grease point (See page 63).
  9. Stand the outboard motor up vertically in a dry place.

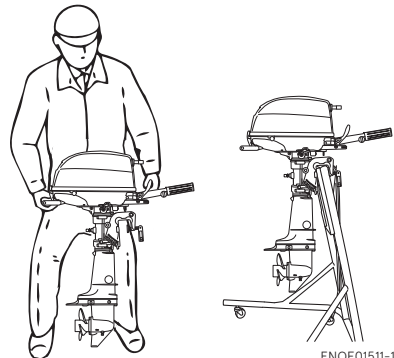

ENOF01511-1

ENOW00066-B

#### ⚠ CAUTION

Do not carry or store the outboard motor in any position shown below. Otherwise, engine oil or cooling water may enter the cylinder cause engine problems. Property damage could result from leaking oil out.



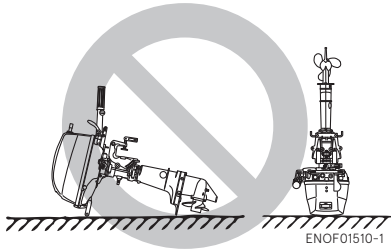

ENOM00441-0

If the outboard motor must be laid down, be sure to drain the remaining fuel in the fuel line and carburetor (see page 65). When laying down the outboard motor, place front-side, starboard-side, or port-side down on a cushion or any softer surface shown below.

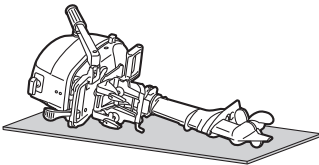
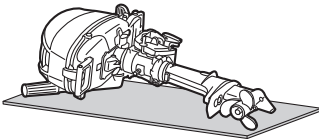

ENOF01532-0

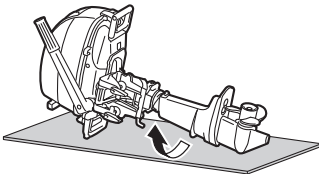

ENOF01533-0

ENON00941-0

**Note**

When laying the outboard front-side down, turn the clamp bracket 90° clockwise or anti-clockwise so that it does not interfere with the ground. Then tighten up

the steering adjustment screw to maintain its position (see page 48).

ENOM00950-0

**Adding a fuel stabilizer**

When adding a fuel stabilizer additive (commercially available), first fill the fuel tank with fresh fuel. If the fuel tank is only partially filled, air in the tank can cause the fuel to deteriorate during storage.

1. Before adding fuel stabilizer additive, drain the carburetor (See page 65).
2. Follow the instructions on the label when adding the fuel stabilizer additive.
3. After adding the additive, let the outboard motor run in the water for 10 minutes to make sure any old fuel in the fuel system has been completely replaced by the fuel with additive.
4. Turn the engine OFF

ENON00891-0

**Note**

If your motor is used occasionally, it is recommended to use a good fuel stabilizer in every tank of fuel and keep the container full to reduce condensation and evaporation.

ENOM00970-0

**Fuel system draining**

ENOW00028-A

**! WARNING**

For details on handling fuel, contact an authorized dealer.

**Fuel and fuel vapors are extremely flammable and can be explosive.**

- If fuel is spilled, wipe it up immediately.
- Keep the fuel tank well away from sources of ignition, e.g. sparks or open flames
- Perform all work outdoors or in a well ventilated place.

ENOW00097-0

**WARNING**

**Be sure to use cloth to remove fuel remaining in the cowl and dispose of it in accordance with local fire prevention and environment protection regulations.**

1. Disconnect the fuel hose from the outboard motor (separate fuel tank). Turn off the fuel cock (integral fuel tank).
2. Remove the top cowl.
3. Place an approved fuel container under the drain screw and use a funnel to avoid spilling fuel.
4. Loosen the carburetor drain screw.
5. Tilt up the outboard motor until fuel flows out of the drain hole.
6. Leave the outboard motor in this position until all fuel has been drained.
7. When thoroughly drained, retighten the drain screw securely.
8. Check the drained fuel for the presence of water or other contaminants. If either is present, reassemble the outboard motor, refill the carburetor with fuel, and then drain the fuel again. Repeat this procedure until no water or other contaminants are present in the drained fuel.

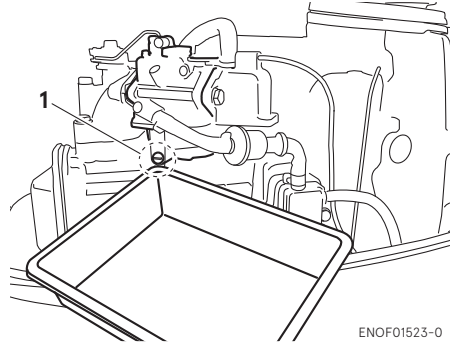

1. Carburetor drain screw

ENOM00102-0

**Battery**

ENOW00931-A

**WARNING**

- **Place the battery away from any source of fire, sparks and open flames such as burners or welding equipment.**
- **Place the battery away from fuel tank. Accidental sparks of battery may cause explosion of gasoline.**

1. Disconnect the battery cables and be sure to remove the negative terminal first.
2. Wipe off any chemical deposits, dirt, or grease.
3. Apply grease to the battery terminals.
4. Charge the battery completely before storing it for the winter.
5. Recharge the battery once a month to prevent it from discharging and the electrolyte from deteriorating.
6. Store the battery in a dry place.

ENOM00104-A

## 4. Pre-season check

The following steps must be taken when first using the engine after off season storage.

1. Check that the shift and throttle function properly. (Be sure to turn the propeller shaft when checking the shift function or else the shift linkage may be damaged.)
2. Check the electrolyte level, and measure the voltage and specific gravity of the battery.

Specific Gravity at 20°	Terminal Voltage (V)	Charge Condition
1.120	10.5	Fully discharged
1.160	11.1	1/4 charged
1.210	11.7	1/2 charged
1.250	12	3/4 charged
1.280	13.2	Fully charged

3. Check that the battery is secure and the battery cables are properly installed.
4. Change the engine oil (See page 56).
5. Before starting the engine, disconnect stop switch lock and crank approximately 10 times in order to prime the oil pump.
6. Fill fuel tank completely.
7. Start the engine and warm up the engine for 3 minutes in the "NEUTRAL" position.
8. Run the engine for 5 minutes at the slowest speed.

9. Run the engine for 10 minutes at half throttle. The oil used for storage inside the engine will be circulated out to assure optimum performance.

ENOM00105-C

## 5. Submerged outboard motor

ENOW00098-0

### CAUTION

**Do not attempt to start submerged outboard motor immediately after it is recovered, or engine could be severely damaged.**

After taking your outboard motor out of the water, immediately take it to your dealer.

The following are the emergency measures to be taken for a submerged outboard motor, if you can not take it your dealer right away.

1. Wash the outboard motor with fresh water to remove salt or dirt.
2. Remove the engine oil drain screw and completely drain water and oil from the engine.
3. Remove the spark plugs, and completely drain the water from the engine by pulling recoil starter several times.  
Replace oil to the correct level.  
The oil and filter may need to be changed again after running a short period to get all moisture completely out of the crankcase.
4. Inject a sufficient amount of engine oil through the spark plug holes.  
Pull the recoil starter rope several times to circulate the oil throughout the outboard motor.

ENOM00106-A

## 6. Cold weather precautions

If you moor your boat in cold weather at temperatures below 0°C (32°F), there is the danger of remained water freezing in the cooling water pump, which may damage the pump, impeller, etc. To avoid this problem, submerge the lower half of the outboard motor into the water.

ENOM00107-A

## 7. Striking underwater object

ENOW00935-0

### CAUTION

**Striking the sea bottom or an underwater object may severely damage the outboard motor.**

Follow the procedure below and consult a dealer as soon as possible.

1. Stop the engine immediately.
2. Check the control system, gear case, boat transom etc.
3. Return to the nearest harbor slowly and carefully.
4. Consult a dealer check the outboard motor before operation again.

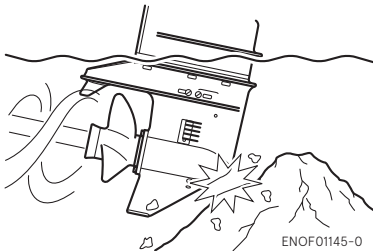

ENOM00120-2

## 8. Auxiliary outboard motor operation

When the auxiliary outboard motor is not in operation, be sure to remove the stop switch lock, shift into forward, and then tilt the outboard motor up. Otherwise, over-rotation of the propeller due to water spray and water ingestion that could cause damage to the outboard motor.

# TROUBLESHOOTING

ENOM00436-0

If you encounter a problem, consult the check list below to determine the cause and to take the proper action.

An authorized dealer will always be happy to provide any assistance and information.

	Engine failing to start	Engine starting but stopping soon	Poor idling	Poor acceleration	Engine speed abnormally high	Engine speed abnormally low	Boat speed low	Overheating of engine	Warning lamp ON	Possible cause
FUEL SYSTEM	●	●								Empty fuel tank
	●	●	●	●		●	●	●		Incorrect connection of fuel system
	●	●	●	●		●	●	●		Air entering fuel line
	●	●	●	●		●	●	●		Deformed or damaged fuel hose
	●	●	●	●		●	●	●		Closed air vent on fuel tank
	●	●	●	●		●	●	●		Clogged fuel filter, fuel pump, or carburetor
			●	●		●	●	●		Use of improper engine oil
			●	●			●	●		Use of improper gasoline
			●	●						Excessive supply of fuel
ELECTRICAL SYSTEM						●	●	●		Poor carburetor adjustment
	●	●	●	●		●	●	●		Spark plug other than specified
	●	●	●	●		●	●			Dirt, soot, etc. on spark plug
	●	●								No Spark or weak spark
	●									Short circuit of engine stop switch
	●		●	●			●	●		Ignition timing incorrect
	●									Lock plate not fitted
COMPRESSION & OIL SYSTEM		●	●	●		●	●			Disconnection of wire or loose ground connection
			●					●		Low compression
				●			●			Carbon deposits in the combustion chamber
ENGINE OIL SYSTEM								●		Incorrect valve clearance
								●		Low oil pressure/level
						●		●		Low oil level
								●	●	Use of improper oil
						●		●	●	Oil deterioration
						●		●	●	Clogged oil strainer
					●		●	●	Faulty oil pump	

		Engine failing to start	Engine starting but stopping soon	Poor idling	Poor acceleration	Engine speed abnormally high	Engine speed abnormally low	Boat speed low	Overheating of engine	Warning lamp ON	Possible cause
OTHERS	●			●	●		●	●			Incorrect adjustment of throttle link
								●	●		Insufficient cooling water flow, clogged or defective pump
				●				●	●		Faulty thermostat
					●	●		●	●		Cavitation or ventilation
					●	●	●	●	●		Incorrect propeller selection
				●	●	●	●	●	●		Damaged or bent propeller
					●	●		●	●		Improper thrust rod position
					●	●	●	●	●		Unbalanced load on boat
					●	●	●	●	●		Transom too high or too low

# TOOL KIT AND SPARE PARTS

ENOM00437-0

Items		Quantity	Remark		
Service tools	Tool bag	1			
	Pliers	1			
	Socket wrench	1			10 × 13 mm
	Socket wrench	1			16 mm
	Socket wrench handle	1			
	Screwdrivers	1			Cross-and straight-point
	Screwdriver handle	1			
Spare parts	Emergency starter rope	1	NGK: DCPR6E		
	Spark plug	1			
	Split pin	1			
	Stop switch lock	1			
Parts Packaged with Engine	Fuel tank	1	12 L	Separate fuel tank model only	
	Primer bulb	1 set			

# PROPELLER TABLE

ENOM00438-0

Use a genuine propeller.

A propeller must be selected so that the engine RPM measured at wide open throttle while cruising is within the recommended range.

4: 4500–5500 min<sup>-1</sup> (rpm)

5: 4500–5500 min<sup>-1</sup> (rpm)

6: 5000–6000 min<sup>-1</sup> (rpm)

	Propeller Mark	Propeller Size (Diameter × pitch)		Standard propeller on the model		
		inch	mm	4	5	6
Light boats	9	7.9 × 9.0	200 × 229			
	8	7.8 × 8.0	198 × 203		S, L	S, L
	7	7.8 × 7.0	198 × 178	S, L		
Heavy boats	6	7.9 × 6.0	200 × 152			*UL

S: Short shaft

L: Long shaft

UL: Extra long shaft

\*: SP model



## EMISSION CONTROL SYSTEM INFORMATION

ENOM01000-0

### Emission Sources

Carbon monoxide, oxides of nitrogen and hydrocarbons are produced in the course of the combustion process. Controlling production of oxides of nitrogen and hydrocarbons is very important because they react to form a photochemical smog under certain conditions when subjected to sunlight. Carbon monoxide does not react in the same way, but is a toxic byproduct.

ENOM01001-0

### Ignition Timing Control System

To reduce the amount of HC, CO and NOx produced, the ignition timing control system continuously adjusts the ignition timing.

ENOM01003-0

### Clean Air Acts of the United States and California, and Environment Canada

EPA, California, and Canadian regulations require all manufacturers to provide written instructions that describe the operation and maintenance of commercial emission control systems.

The following instructions and procedures must be followed in order to keep the emissions from your engine within these emission standards.

ENOM01004-0

### Tampering and Modifications

Tampering is a violation of the Federal Laws of the United States and California.

Tampering with or altering the emission control system could cause emissions to increase beyond legal limits. The following acts, although not all inclusive, are considered as tampering:

- Removing or modifying any part of the intake, fuel or exhaust system.
- Modifications that cause the engine to operate outside its design parameters.

ENOM01005-0

**Problems that can affect emission**

If you notice any of the following symptoms, have your outboard motor inspected and repaired by an authorized Tohatsu service dealer before further use.

- Hard starting or stalling immediately after starting
- Rough idling
- Misfiring/backfiring under load
- Afterburning (backfiring)
- Black exhaust smoke or increased fuel consumption

ENOM01006-0

**Replacement Parts**

The emission control system in your Tohatsu outboard motor has been designed, built, and certified to conform with the EPA and California emission regulations. Whenever requesting maintenance, use of Tohatsu Genuine parts is highly recommended. Tohatsu Genuine parts constitute replacement parts manufactured to the same high standards as the original parts, thus guaranteeing uninterrupted high performance of your outboard motor. The use of replacement parts other than Tohatsu Genuine parts could jeopardize the effectiveness of the emission control system.

Tohatsu, as a manufacturer of aftermarket parts, assumes the responsibility that replacement parts will not adversely affect emission performance. The manufacturer or rebuilder of the replacements

parts must certify that use of the parts will not result in a failure of the engine to comply with these regulations.

ENOM00033-0

---

**Low permeation fuel hose requirement**

---

**EQUIPPED FOR UNITED STATES AND CANADA MODEL**

Required for outboards manufactured for sale, sold, or offered for sale in the United States.

- TOHATSU engine has used fuel hoses for The Environmental Protection Agency (EPA) requires from January 1, 2011.

ENOM00034-A

## EPA pressurized portable fuel tank requirements

### EQUIPPED FOR UNITED STATES AND CANADA MODEL

The Environmental Protection Agency (EPA) required portable fuel systems that are produced after January 1, 2011 for use with outboard engines to remain fully sealed (pressurized) up to 34.4 kPa (5.0 psi). These tanks may contain the following:

- An air inlet that opens to allow air to enter as the fuel is drawn out of the tank.
- An air outlet that opens (vents) to the atmosphere if pressure exceeds 34.4 kPa (5.0 psi). A hissing noise may be heard as the tank vents to the atmosphere. This is normal.
- When installing the fuel tank cap, turn the cap to the right until you hear two clicks. This signals that the fuel cap is fully seated. A built-in device prevents overtightening.
- The fuel tank has a manual vent screw which should be closed for transportation and full open for operation and cap removal.

Since sealed fuel tanks are not openly vented, they will expand and contract as the fuel expands and contracts during heating and cooling cycles of the outside air. This is normal.

ENOM00036-0

## EPA approval Primer bulb/hose assembly

### EQUIPPED FOR UNITED STATES AND CANADA MODEL

TOHATSU adopts Primer bulb/hose assembly approved by the Environment Protection Agency (EPA).

Please use the EPA approved primer bulb/hose assembly with the identification mark on the fuel connector.



ENOF00111-0

ENOW00021-0

### ⚠ CAUTION

**Be sure to use EPA approved tank and EPA approved primer bulb/hose assembly as a set. Confirm shapes of EPA approved tank and regular tank.**

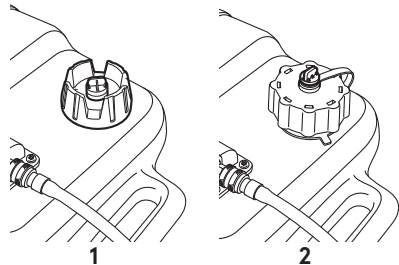

ENOF00024-1

1. Except for U.S. model (regular tank)
2. For U.S. and Canada model (EPA approved tank)

ENOM01007-0

**Maintenance**

Follow the maintenance schedule presented on page 70. Keep in mind that this schedule is based on the assumption that the outboard motor will only be used for its intended purpose. Operation under sustained high loads or other unusual conditions will require more frequent service.

ENOM01008-0

**Star label**

This outboard motor is labeled with the California Air Resources Board (CARB) star label. A description of this label is presented below.

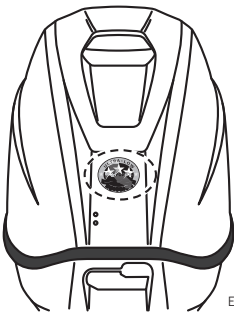

ENOF01000-0



ENOF01001-0

ENOM01009-0

**One Star-Low Emission**

One Star- Low emission The one-star

label identifies engines that meet the Air Resources Board's Personal Watercraft and Outboard marine engine 2001 exhaust emission standards.

Engines meeting these standards have 75% lower emissions than conventional carbureted two-stroke engines.

These engines are equivalent to the U.S. EPA's 2006 standards for marine engines.



ENOF01002-0

ENOM01010-0

**Two Stars-Very Low Emission**

The two-star label identifies engines that meet the Air Resources Board's Personal Watercraft and Outboard marine engine 2004 exhaust emission standards.

Engines meeting these standards have 20% lower emissions than One Star-Low Emission engines.



ENOF01003-0

ENOM01011-0

**Three Stars-Ultra Low Emission**

The three-star label identifies engines that meet the Air Resources Board's Personal

Watercraft and Outboard marine engine 2008 exhaust emission standards or the

Sterndrive and Inboard marine engine 2003-2008 exhaust emission standards. Engines meeting these standards have 65% lower emissions than One Star-Low Emission engines.



ENOM01012-0

#### **Four Stars-Super Ultra Low Emission**

The four-star label identifies engines that meet the Air Resources Board's Stern-drive and Inboard marine engine 2009 exhaust emission standards.

Personal Watercraft and Outboard marine engines may also comply with these standards.

Engines meeting these standards have 90% lower emissions than One Star-Low Emission engines.

# OWNER'S MANUAL

MFS 4D  
MFS 5D  
MFS 6D

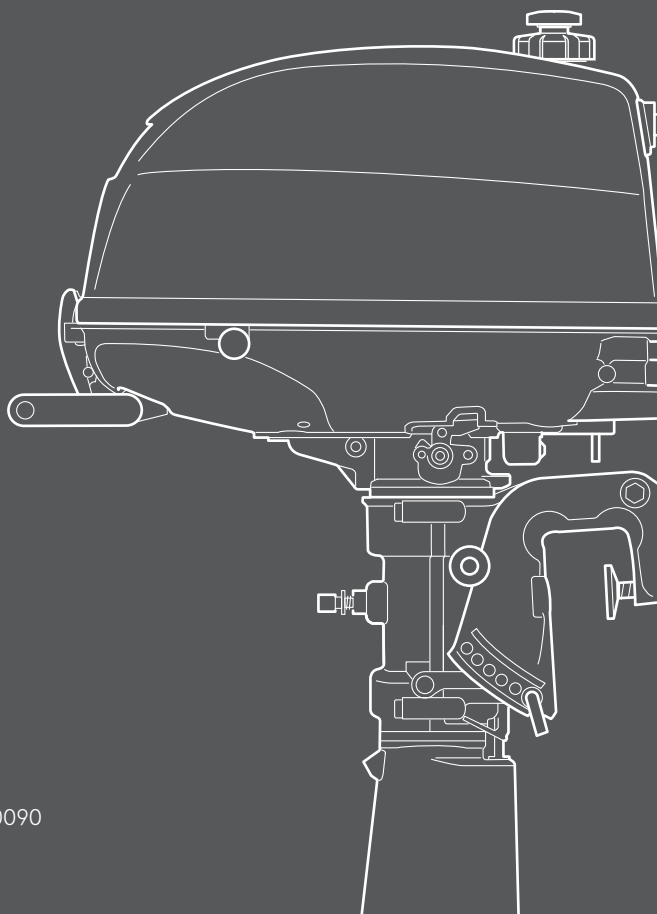

**TOHATSU CORPORATION**

5-4, Azusawa 3-Chome, Itabashi-Ku  
Tokyo 174-0051, Japan  
Tel: +81-3-3966-3117 Fax: +81-3-3966-0090  
[www.tohatsu.com](http://www.tohatsu.com)